

# HEAT RECOVERY UNIT WENTILO ICON IS

User manual

## MODELS:

IS250 S1 AA	IS330 S1 AA
IS250 S1 AB	IS330 S1 AB
IS250 E1 AA	IS330 E1 AA
IS250 E1 AB	IS330 E1 AB
IS250 S4 AA	IS330 S4 AA
IS250 S4 AB	IS330 S4 AB
IS250 E4 AA	IS330 E4 AA
IS250 E4 AB	IS330 E4 AB

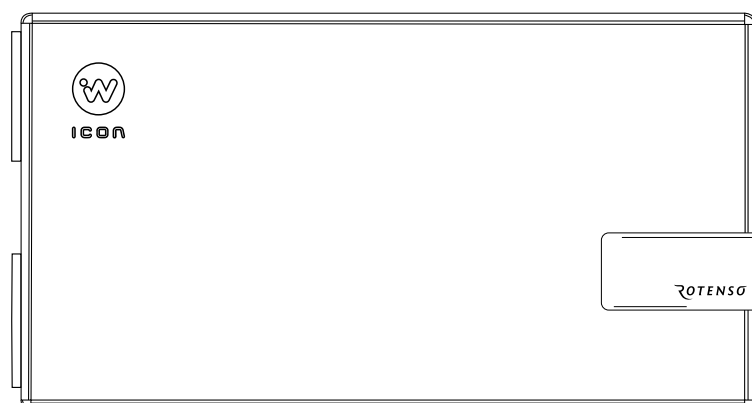



## Table of contents

<b>1. Basic Information</b>	<b>4</b>
1.1 General information	4
1.2 Precautions	5
1.3 Conditions of use	7
1.4 Operating principle	7
1.5 Scope of responsibility	7
1.6 Technical data of the device	7
1.7 Scope of delivery	8
<b>2. Switching the heat recovery unit on and off</b>	<b>8</b>
<b>3. Control panel operation</b>	<b>8</b>
3.1 Remote control of the heat recovery unit	9
3.2 Create user account in the iCONNECT mobile application	9
3.3 iSWITCH Ti control panel	10
3.3.1 Operation of the iSWITCH Ti panel	10
3.3.2 Adding the iSWITCH Ti panel to the user account	10
3.3.3 Adding an installation component	16
3.4 iSENSE 5i control panel	17
3.4.1 Switching the heat recovery unit on	17
3.4.2 Adding the iSENSE 5i panel to the user account	17
3.4.3 Adding an installation component	20
3.4.4 Home screen	21
3.4.5 Menu	23
3.4.6 Schedules	23
3.4.6.1 Ventilation intensity schedule	24
3.4.6.2 Temperature schedule	26
3.4.7 Settings	28
3.4.8 Momentary operation modes	31
3.4.9 Complementary devices	35
3.4.10 Alarms	35
3.4.11 Advanced	36
<b>4. Maintenance</b>	<b>39</b>
4.1 Air filters replacement	39
4.2 Heat exchanger cleaning	41
4.3 Cleaning the heat recovery unit housing	42
<b>5. Faults and operating indications</b>	<b>43</b>
5.1 Faults without indication	43
5.2 Faults with indication	43
<b>6. Disposal and recycling</b>	<b>45</b>
<b>7. Technical specification</b>	<b>46</b>
Rotenso Wentilo ICON IS250   IS330	46

## 1. Basic Information

### 1.1 General information

This user manual is aimed at users of the Rotenso Wentilo ICON IS series heat recovery units. Please read the heat recovery unit user manual before using the unit.

The latest version of the user manual is available at [rotenso.com](http://rotenso.com).

#### This documentation applies to equipment:

Group	Series	Housing type	Flow rate max (m3/h)	Exchanger type*	Control system**	Generation	Version
Wentilo	ICON	IS	250	S	1	A	A
Wentilo	ICON	IS	250	E	1	A	A
Wentilo	ICON	IS	250	S	4	A	A
Wentilo	ICON	IS	250	E	4	A	A
Wentilo	ICON	IS	330	S	1	A	A
Wentilo	ICON	IS	330	E	1	A	A
Wentilo	ICON	IS	330	S	4	A	A
Wentilo	ICON	IS	330	E	4	A	A
Wentilo	ICON	IS	250	S	1	A	B
Wentilo	ICON	IS	250	E	1	A	B
Wentilo	ICON	IS	250	S	4	A	B
Wentilo	ICON	IS	250	E	4	A	B
Wentilo	ICON	IS	330	S	1	A	B
Wentilo	ICON	IS	330	E	1	A	B
Wentilo	ICON	IS	330	S	4	A	B
Wentilo	ICON	IS	330	E	4	A	B

\*S - airENERGY; E - airENTHALPY; \*\*1 - iEDGE; 4 - iEDGE SMART;

## 1.2 Precautions

The safety precautions in the user manual must be strictly adhered to, as ignoring these instructions may result in death or serious injury. The precautions listed in the document are divided into the following categories. Read the instructions carefully before turning on the appliance. Keep the manual in an easily accessible place for later reference.

### Meaning of the symbols DANGER, WARNING, CAUTION and NOTE.

#### **DANGER**

Denotes a dangerous situation, the occurrence of which may result in death or serious injury.

#### **WARNING**

Denotes a potentially dangerous situation, the occurrence of which may result in death or serious injury.

#### **CAUTION**

Denotes a potentially dangerous situation, the occurrence of which may result in minor or moderate injury. It also serves as a warning against unsafe practices.

#### **NOTE**

Indicates situations that may cause accidental damage to equipment or property.

#### **DANGER**

Before connecting the unit to the mains, ensure that the ventilation ducts are firmly fixed to the heat recovery unit.

#### **WARNING**

This appliance is not intended for use by persons (including children) with reduced physical, sensory or mental capabilities, or lack of experience and knowledge, unless they have been given supervision or instruction concerning use of the appliance by a person responsible for their safety. Children should be supervised to ensure that they do not play with the appliance.

**cont. 1.2 Precautions**

 **WARNING**

If the supply cord is damaged, it must be replaced by the manufacturer, its service agent or similarly qualified persons in order to avoid a hazard.

 **WARNING**

Incorrect installation of equipment or accessories can cause electric shock, fire, flooding or damage to the equipment. Use only accessories designed for use with the equipment. Have it assembled by a qualified person.

 **WARNING**

It is forbidden to modify or repair the unit yourself - only qualified installers are allowed to do this.

 **CAUTION**

In order to use a Rotenso brand heat recovery unit safely, the installation should be carried out by a qualified installer.

 **CAUTION**

It is forbidden to cover or reduce the cross-section of spigots connections.

### 1.3 Conditions of use

The heat recovery unit must be installed in a room where the air temperature is maintained between +5°C and +45°C. The relative humidity of the air in the room where the heat recovery unit is installed should be maintained at a level that ensures no condensation on the surface of the housing and on the surfaces of the unit's components. Unit must not be exposed to precipitation or direct sunlight. The air supplied to the heat recovery unit should not contain hazardous substances, i.e. chemical fumes, flammable, explosive mixtures, coarse dust.

**NOTE**

Regular filter replacements are essential for proper heat recovery unit operation. Excessive dirtiness of the filters reduces the efficiency of the heat recovery unit and increases the noise level.

### 1.4 Operating principle

The heat recovery unit provides a continuous exchange of used air from the building for fresh air drawn from outside with simultaneous heat recovery from the extract air and filtration of the supply air. The unit recovers heat from the extract air with an efficiency of up to 90%, reducing the heating costs of the building and increasing the comfort of the occupants by supplying air at a temperature close to room temperature. Variable speed energy-efficient fans ensure low electricity consumption. Units equipped with an airENTHALPY heat exchanger additionally recover moisture from the exhaust air, increasing the humidity of the supply air.

#### Supply air quality is ensured by 4 air treatment stages:

- 1 **STAGE 1:** anti-pollen filter iCARE G4 Coarse 75% removes 75% of particles larger than 10 µm
- 2 **STAGE 2:** anti-smog filter iCARE F7 ePM1 70% removes 70% of particles smaller than 1 µm  
removes 80% of particles smaller than 2.5 µm  
removes 93% of particles smaller than 10 µm
- 3 **STAGE 3:** The airCare+ antibacterial coating reduces bacterial growth in the appliance
- 4 **STAGE 4:** airION air ioniser

The condensate generated by the heat transfer of the exhaust air is discharged into a condensate drain.

Principle diagram of the counterflow exchanger for Standard (A) version.

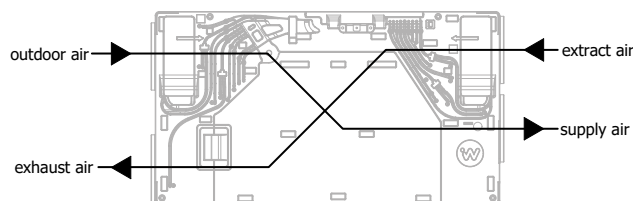

Principle diagram of the counterflow exchanger for Alternative (B) version.

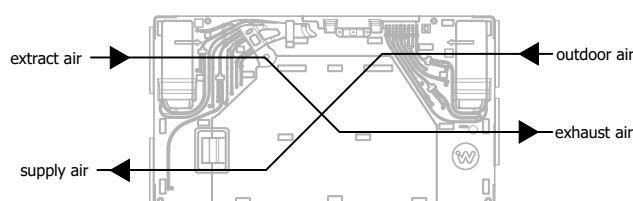

### 1.5 Scope of responsibility

Thermosilesia Sp. z o.o. Sp. k. is not liable for damages resulting from the use of the equipment not in compliance with the user manual and the assembly and maintenance manual.

### 1.6 Technical data of the device

The basic specifications of the heat recovery unit are included on the nameplate, which is located on the heat recovery unit housing, to the right of the control system compartment and on the shipping carton. When contacting the manufacturer's service, indicate the serial number of the appliance, indicated by the SN symbol on the nameplate.

Additional technical data can be found in the product fiche and the data sheet.

**ROTENSO®** HEAT RECOVERY UNIT WENTILO ICON IS250 S4 AB

Made in Poland Thermosilesia Sp. z o.o. Sp.k.  
ul. Szyb Walenty 16  
41-700 Ruda Śląska

rotensso.com

PC/EAN: 5 905567 600210

SN: IS250S4AB000001

Power supply	1-230VAC @ 50Hz
Rated current	6,7 A
Net weight	20,8 kg
Gross weight	24,0 kg
Operating temperature	5-45°C
Protection level	IP20
Manufactured	2024

PL Wyrób poddany działaniu produktu biobójczego, zawiera środek konserwujący (szkło srebrowo-fosforanowe), który przeciwdziała rozwojowi mikroorganizmów na powierzchni wyrobu pokrytego farbą o właściwościach biobójczych.

EN Product coated with a biocidal varnish, contains an active ingredient (silver-phosphate glass) that prevents the growth of microorganisms on the surface.

## 1.7 Scope of delivery

The package should include:

Scope of delivery	unit	quantity
Wentilo ICON IS heat recovery unit	pc.	1
User manual	pc.	1
Condensate drain connection	pc.	1
Mounting template	pc.	1
Energy label	pc.	1

## 2. Switching the heat recovery unit on and off

### DANGER

Before connecting the unit to the mains, ensure that the ventilation ducts are firmly fixed to the heat recovery unit.

### Switching on

- 1** *Insert* the mains plug into the socket
- 2** On the technical cover, **switch** the power button from  to **I**

### Off

- 1** On the technical cover, **switch** the power button from position **I** to 
- 2** *Pull* the mains plug out of the socket

### Stand-by mode

The device can be put into stand-by mode from the control panel, the mobile app or the website by clicking/off icon. Turn on of the device from stand-by mode is performed similarly.

## 3. Control panel operation

For proper operation, the unit should be equipped with an iSWITCH Ti or iSENSE 5i control panel, which must be purchased separately. Once properly configured, both panels allow the unit to be controlled using the iCONNECT mobile app and the iCONNECT WEB service.

The iCONNECT app is available for download from Google Play and the App Store.

The iCONNECT WEB service is available at [wentilo.com](http://wentilo.com). A full user manual for the iCONNECT application and iCONNECT WEB service is available at [rotenso.com](http://rotenso.com).

Appearance of the iCONNECT application icon



iCONNECT

### CAUTION

Control panel should be installed by a qualified installer.

### NOTE

Control panel is designed for wall mounting, in dry rooms only. The panel must not be used in condensation conditions and must be protected from water.

### NOTE

In order to reduce interference with the panel's temperature measurements, avoid locations with strong sunlight, poor air circulation, close to heating equipment, directly next to doors and windows (typically min. 200 mm from the edge of the door).



### 3.1 Remote control of the heat recovery unit



The user can control the heat recovery unit using the iCONNECT application installed on the mobile device, i.e. an Android or iOS phone or tablet. The app allows full real-time monitoring and control of the unit, selection of momentary modes or reading parameter graphs from the unit's history. The above functions can be accessed by creating a user account, adding the panel to the user account and adding the installation component.

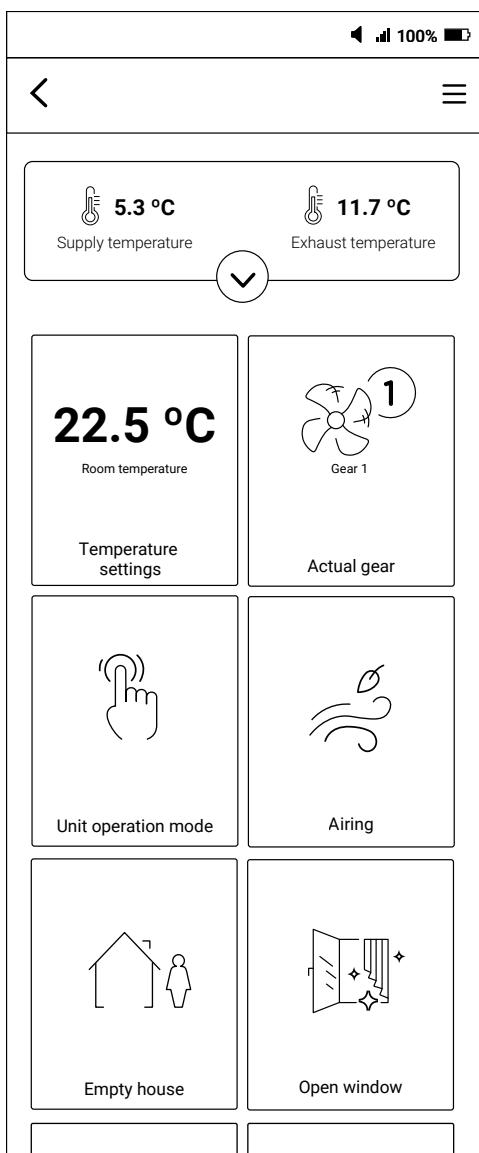

#### iCONNECT WEB

Once the unit is fully configured, the user can also control the heat recovery unit via the iCONNECT WEB service available at the **wentilo.com** website. The internet service enables full real-time monitoring and control of the device, selection of momentary modes or reading of parameter graphs from the device history. Access to the above functions is possible after creating a user account, adding a panel to the user account and adding an installation component.

### 3.2 Create user account in the iCONNECT mobile application

The iCONNECT mobile application allows the installation to be added to a user account and allows the heat recovery unit connected to a WiFi network to be controlled. For these processes it is necessary to set up a user account, as described in the instructions below.

#### Downloading the iCONNECT mobile application



The iCONNECT app is available for download from Google Play and the App Store. Download, install and launch the mobile app.

#### Account registration

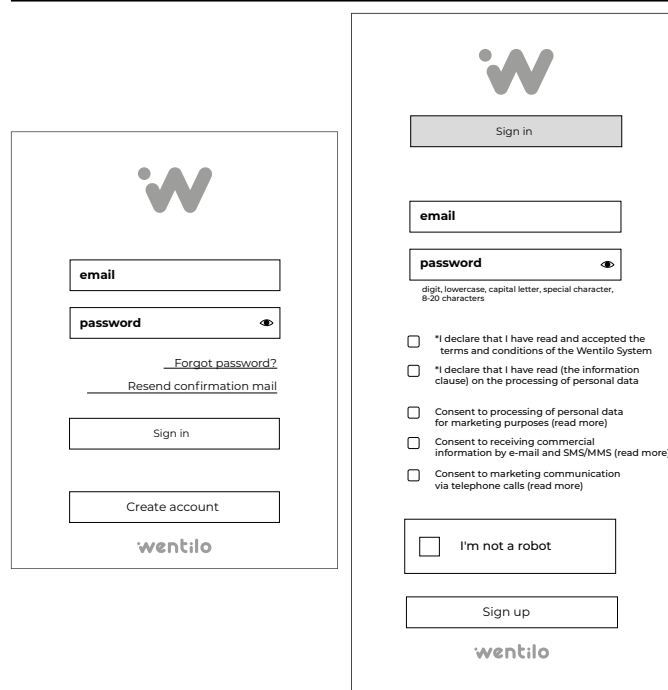

- ▶ After starting the application, the login window will appear. For the first login, **click** the tile: **Create account**, which will open a new window.
- ▶ In the account registration window, you will need to **enter** your email address and password and additionally **accept** all necessary statements and optionally marketing consents.
- ▶ The checkbox **I am not a robot** must then be **ticked** and then **click** the **Sign up** tile.
- ▶ An activation link will be sent to the email address provided. Once registration is confirmed, the account becomes active.

### 3.3 iSWITCH Ti control panel

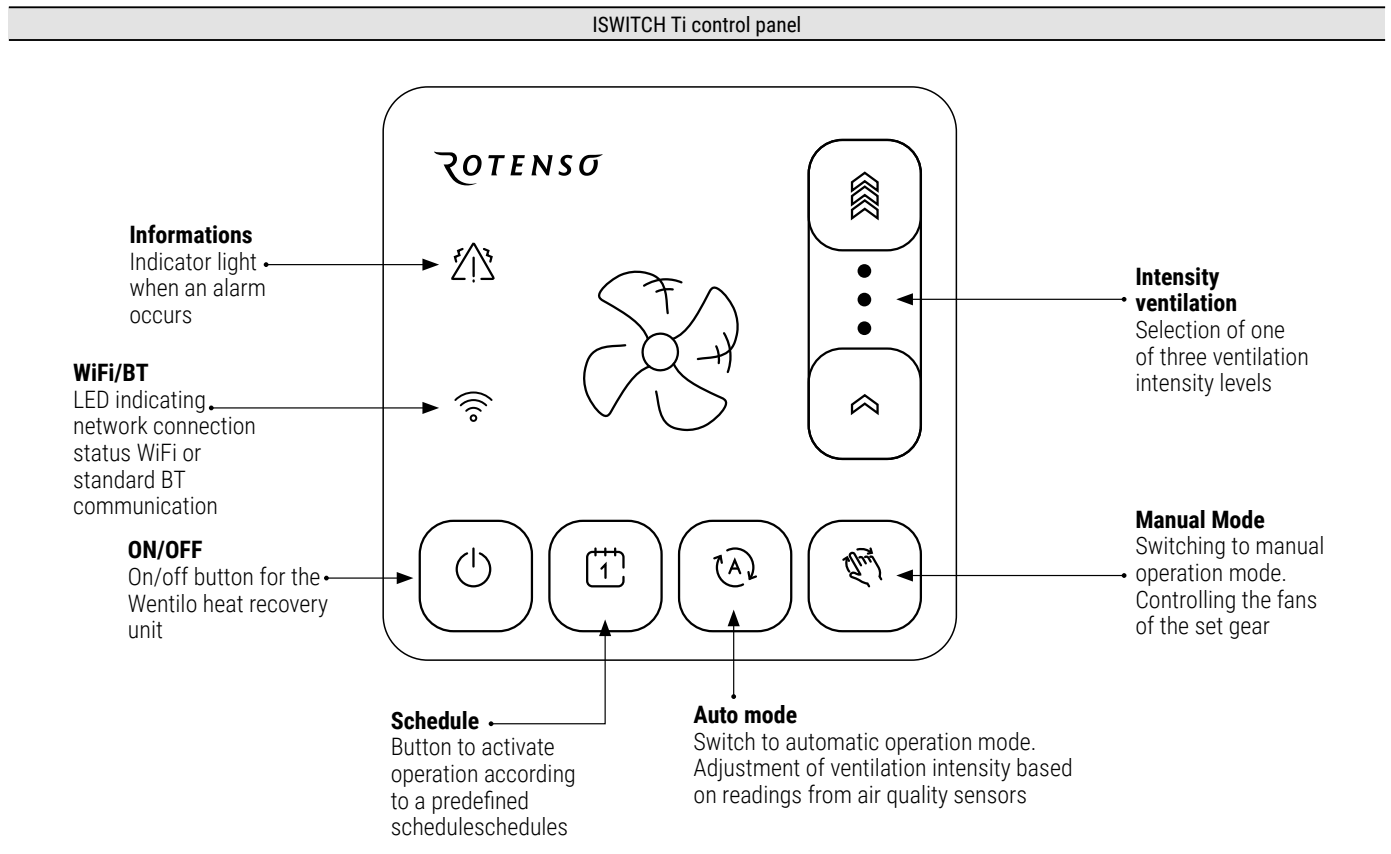

The iSWITCH Ti control panel is a panel equipped with a sensor array. The control panel allows direct control of basic functions such as changing the gear of the fans, changing the operation mode and switching to stand-by mode. Built-in WiFi and BT modules also allow the heat recovery unit to be controlled via the iCONNECT mobile application or via the iCONNECT WEB service. An integrated temperature and humidity sensor allows the heat recovery unit operation to be matched to the room conditions.

#### 3.3.1 Operation of the iSWITCH Ti panel

Basic operation of the control panel occurs by touching the selected iSWITCH Ti control panel function button.

##### Button symbols and LED indications mean:

	Turn on or off the heat recovery unit.
	Turn on (LED lit continuously) the heat recovery unit operation mode according to the set time schedule. If the time schedule is not set or enabled, the LED flashes.
	Turn on (LED lit continuously) the heat recovery unit's automatic operation mode.
	Turn on (LED lit continuously) the manual operation mode of the heat recovery unit.
	Increase or decrease the gear/power of the fans. The function only works when the manual operation mode is ON.

	Active control panel event signalling.
	Active connection to WiFi network or via BT

With the iSWITCH Ti control panel it is not possible to verify all the operating parameters of the system, but only the basic functions of the heat recovery unit.

#### 3.3.2 Adding the iSWITCH Ti panel to the user account

Adding the iSWITCH Ti panel to the user account can be done using the iCONNECT mobile application. Before configuring the iSWITCH Ti panel, follow the steps described in section 3.2 *Create user account in the iCONNECT mobile application.*

In the event of problems, alternatively you can use the Wentilo **Installation Assistant** available in the iCONNECT PRO app, which is available for download on Google Play and the App Store. The iCONNECT PRO application allows you to search

for Rotenso devices available nearby. Searching for and connecting to devices is only performed in the Standard for wireless BT communication.

## Configuration using the iCONNECT application

### 1 Preparation of the iSWITCH Ti panel

The iSWITCH Ti control panel must be switched to BT mode. BT communication is active if the LED next to the  icon flashes several times per second.

If the LED is lit continuously or flashes approximately 1 time per second, **touch** and **hold** the switch on the control panel marked with the symbol:  until all the light elements on the panel start to flicker.

### 2 Login

- ▶ **Open** the iCONNECT app, then **enter** the email address and password you provided when registering your account and **click Login**.

### 3 Creating an installation account

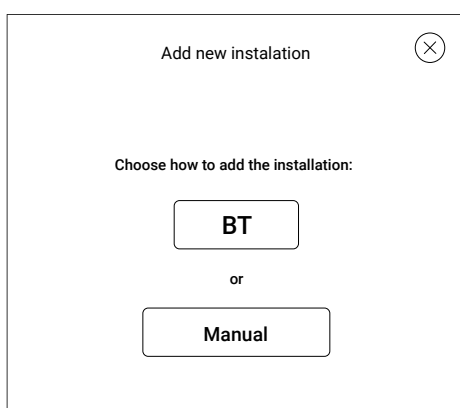

- ▶ After logging in, the **Choose installation** window appears. **Click** the **Add** tile. This will open the **Add new installation** window
- ▶ The User has two options to choose from: **BT** and **Manual**. Select **BT mode**, which automatically detects iSWITCH Ti control panels in the vicinity working in BT (they act as an internet gateway).

**Notes:** in case of problems with the connection in this mode, follow the connection instructions using the **Wentilo Installation Assistant**, whose instructions can be found below.

### 4 Connecting to the panel

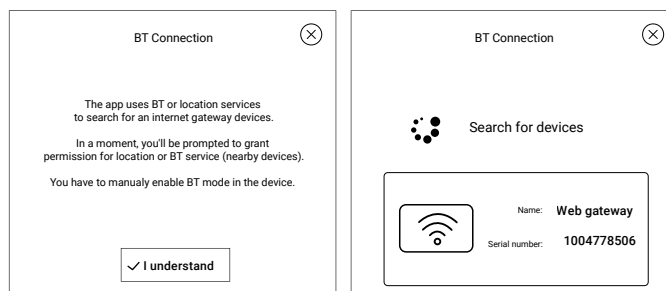

- ▶ User must allow the application to access the location in order to search for nearby devices.
- ▶ When the iSWITCH Ti panel (a nearby device) is found, the application informs the user with an appropriate message. **Click** the web gateway tile, confirming that the appropriate device has been selected.

### 5 Acceptance of terms and conditions

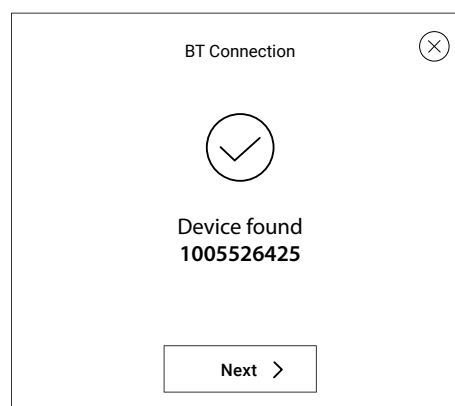

- ▶ Once the device has been selected, a new screen will appear to confirm that communication has been established.
- ▶ **Click Next**. This will open the **Marketing agreements** window. You will need to **grant access** to your personal data and **accept** all necessary statements and optionally marketing consents.

### 6 Choice of installation name

- ▶ You need to **define** the **Name of the installation**, which will be visible in the iCONNECT mobile app and the iCONNECT WEB service. The **name** can be anything you like. After entering the name, confirm it by **clicking** the **Add** button.

**Caution:** If you see the notification *Installation is already added to account*, please contact your supplier.

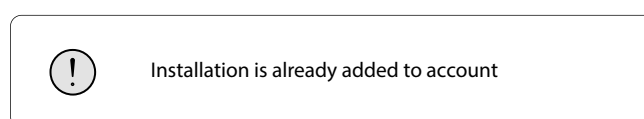

**7** WiFi configuration

- ▶ The user should see the **WiFi Configuration** pop-up. **Select Yes** to start configuring the WiFi module of the iSWITCH Ti panel.
- ▶ **Enter** the **SSID** of the WiFi network and the **password** with which the network is encrypted. Then **click Confirm**. A message should appear informing you that the WiFi configuration has been correctly completed.
- ▶ The iSWITCH Ti panel will switch to WiFi Mode. Once the panel is successfully connected to the WiFi network, you can proceed to the process of adding an installation component as described in section 3.3.3 **Adding an installation component**.  
**NOTE:** WiFi connection is indicated by a steady light next to the icon 📶

**Hint:** if the connection is not successful, follow the section on **changing WiFi settings**.

**8** Changing WiFi settings

- ▶ If you enter an incorrect network **SSID** or password, **switch** the panel to **BT mode** (see section *Preparation of the iSWITCH Ti panel*).
- ▶ Next, in the iCONNECT application, select the installation by **clicking** the **Select** button and then **click WiFi settings**.
- ▶ Allow the application to access the location so that it can search for devices in the vicinity.
- ▶ Once the iSWITCH Ti panel is found, the application informs you with an appropriate message.
- ▶ **Click** the internet gateway tile, confirming the selection of the appropriate device.
- ▶ After a successful connection, the **WiFi Configuration** window opens where you can overwrite your network settings. Once the changes have been made, **click Confirm**. The iSWITCH Ti panel will automatically switch to the WiFi mode.

**Configuration using Wentilo Installation Assistant**

**1** Preparation of the iSWITCH Ti panel

- ▶ The iSWITCH Ti control panel must be switched to BT mode.
- ▶ BT communication is active if the LED next to the 📶 icon flashes several times per second. If the LED is lit continuously or flashes approximately 1 time per second, **touch** and **hold** the switch on the control panel marked with the symbol: ☹ until all the light elements on the panel start to flicker.
- ▶ BT communication mode can be active before the application is launched, or it can be activated while the application is in use - the user may be prompted to do so.

**2** Preparing the phone for connection to iSWITCH Ti



**iCONNECT PRO**

- ▶ The **iCONNECT PRO** app must be **downloaded** and **installed** on the phone from Google Play (for Android phones) or the App Store (for iOS phones).
- ▶ Searching for BT devices via the app requires your phone to have active BT and location settings.
- ▶ **Turn on** these features in your phone's settings, then **open iCONNECT PRO** app and **click** the **Begin** tile.



**3** Consent to use of required functionality

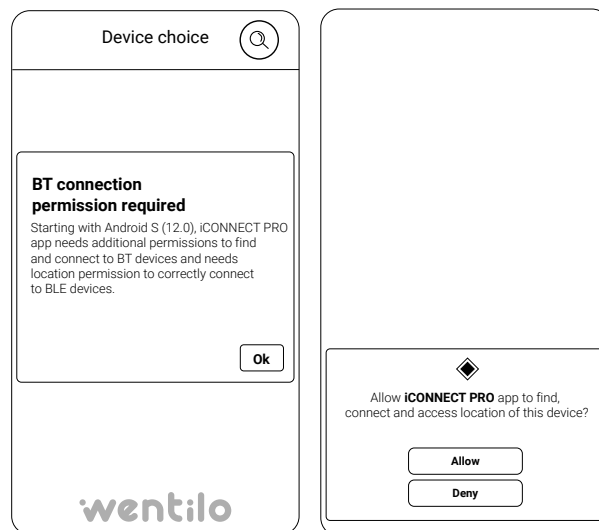

- ▶ The first time the app is launched, the user will be asked for consents to use the required functionalities. In the Android version of the app, the number of messages varies depending on the version of the system used.
- ▶ The consents are one-time only. Once they have been approved, the user will not be asked again for consents to access the phone's functionality.

4 Device search

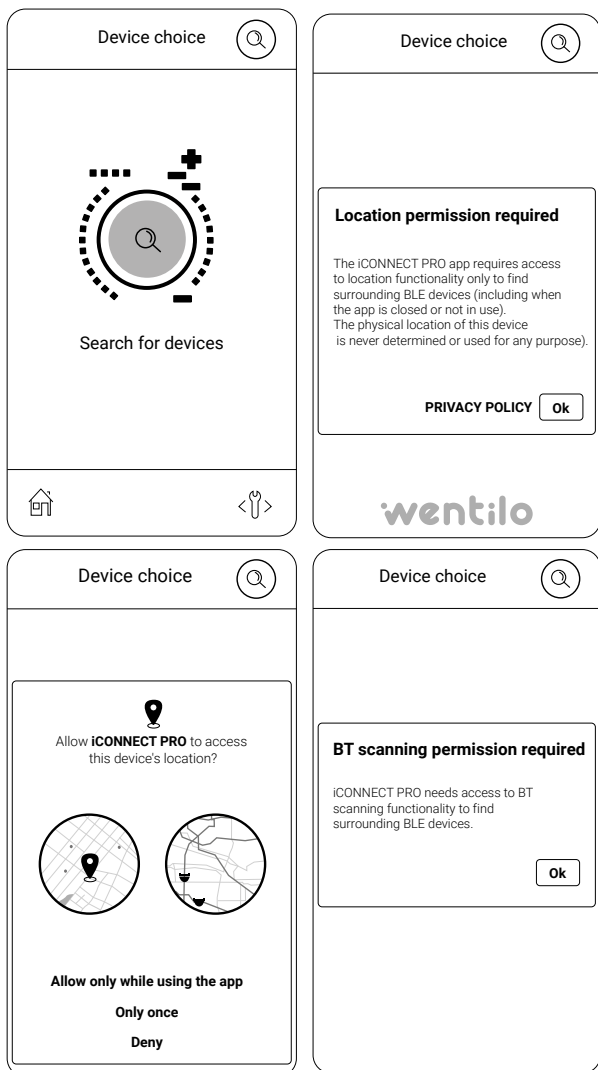

- ▶ Open the next screen: **Device choice**.
- ▶ **Click** the magnifying glass icon in the middle of the screen to search for available devices - iSWITCH Ti panels. Again, the first time the application is launched, the user, depending on the phone's operating system, may be asked to agree to the use of the of the required functionalities.
- ▶ Once all required consents and settings have been approved, the app will begin the process of searching for devices in the vicinity.

Example of iCONNECT PRO application screen with list of available devices in the vicinity

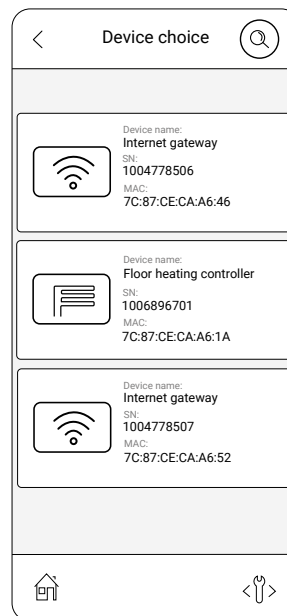

**iCONNECT PRO**  
Searching for devices - troubleshooting

The application automatically detects the available devices - Rotenso control panels, acting as the internet gateway for the entire device. If there is no other active device of the same type and operating in BT mode on the site within a close proximity of a few metres, only one internet gateway item with an SN number should appear on the screen. The last 7 digits of the **SN** number match the serial number of the panel. The **serial number** of the panel can be read on the factory sticker located on the inside of the panel, visible after removing the wall mounting element to which the control cables are connected.

**If the application does not detect the control panel by itself:**

- **click** the magnifying glass button at the top of the screen when the list of available devices is not visible,
- **perform** a swipe gesture (swiping from top to bottom across the list) to refresh it when the list of available devices is visible.

**5** Choice of internet gateway

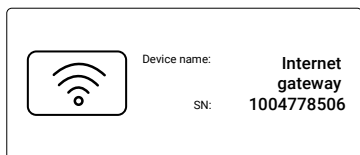

**iCONNECT PRO**

- ▶ If an item with the corresponding **SN** number appears, it is selected by **clicking** a tile on the screen.
- ▶ When you click the tile with the internet gateway icon with the corresponding SN number, the application will connect to the control system main board - labelled "ventilation controller".
- ▶ Once connected to the control panel, the **Selected device** screen will appear. Then **click** the tile: **Add Wentilo installation**, which will launch the installation assistant.

**Note:** The iCONNECT PRO application has a built-in Installation Assistant to help guide the user through the process of adding an installation in the Wentilo service (e.g. iCONNECT application).

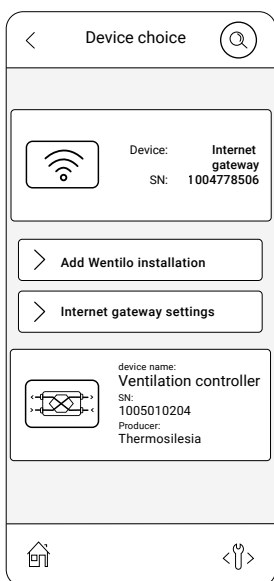

**6** Wentilo Installation Assistant

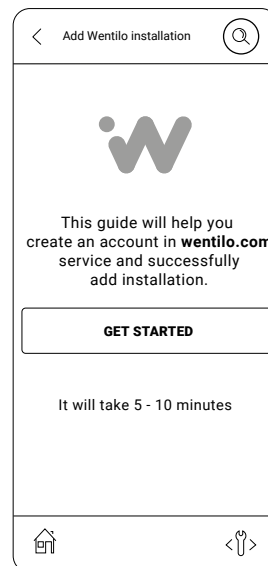

**iCONNECT PRO**

- ▶ Confirm that you wish to start further configuration by **clicking** the **Get started** tile.
- ▶ The Installation Assistant consists of 7 steps. Steps 1 - 4 refer to creating an account in the iCONNECT application or in the iCONNECT WEB service (**wentilo.com**) and logging in with your own account (account registration for users logging in for the first time) and selecting the add installation function.
- ▶ Navigating between the steps is possible using the buttons at the bottom of the screen or by using right/left swipe gestures.

**Note:** In order to complete the process of adding an installation, it is necessary to enter the so-called iCONNECT PRO password (or token), which is a unique and independent sequence of six digits for each device. The Wentilo Installation Assistant allows you to generate a **token** for the installation to be configured.

**7** Wentilo Installation Assistant - step 1 Download the iCONNECT application and register an account

**iCONNECT**

- ▶ Download the application and register an account according to the instructions in section 3.2 **Create user account in the iCONNECT mobile application.**

**iCONNECT PRO**

- ▶ After registering your account, you can proceed to the next step by **clicking Next.**

**8** Wentilo Installation Assistant - step 2 Login

**iCONNECT**

- ▶ When the application opens, **enter** the email address and password you provided when registering your account and **click** the **Login** button.

**iCONNECT PRO**

- ▶ After logging in to your account, you can go to the next step by **clicking** the **Next** button.

**9** Wentilo Installation Assistant - step 3 Create installation account**iCONNECT**

- ▶ After logging in, the **Installation selection** window is displayed.
- ▶ **Click** the **Add** tile.
- ▶ This will open the **Add new installation** window.  
The User has two options to choose from: **BT** and **Manual**. **Manual mode** should be selected.

**10** Wentilo Installation Assistant - step 4 Adding a panel manually**iCONNECT**

- ▶ You need to **define** the **Installation name** that will be visible in the iCONNECT mobile app and the iCONNECT WEB service. The **name** can be anything you wish.

**iCONNECT PRO**

- ▶ Once the account name has been entered, you can proceed to the next step by **clicking Next**. The serial number of the control panel will be displayed, which you need to **enter** in the **Serial number** field in the iCONNECT application.

**Hint:** Serial number can be copied by clicking on it.

**iCONNECT**

- ▶ After filling the **Serial number** field, you can proceed to the next step by **clicking Next**. This will open the **Marketing consents** window. You must **grant access** to your personal data and **accept** all necessary statements and optionally marketing consents.  
User will be asked to enter a **password from the mobile application** (token), which is generated in the next step.

**11** Wentilo Installation Assistant - step 5 Token generation**iCONNECT PRO**

- ▶ Proceed to step 5 by **clicking Next**. The **iCONNECT PRO Password** will be displayed which must be **copied** into the iCONNECT application by **clicking it**.

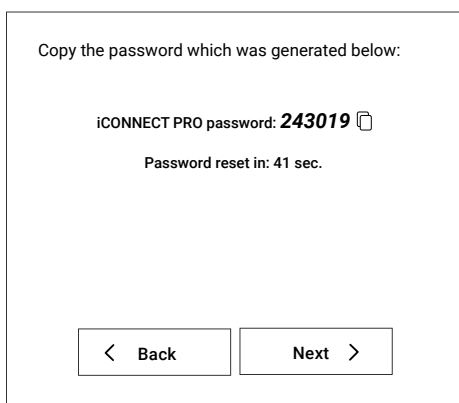

**Note:** the password is generated automatically in real time every approx. 1 minute, without any user input.

**iCONNECT**

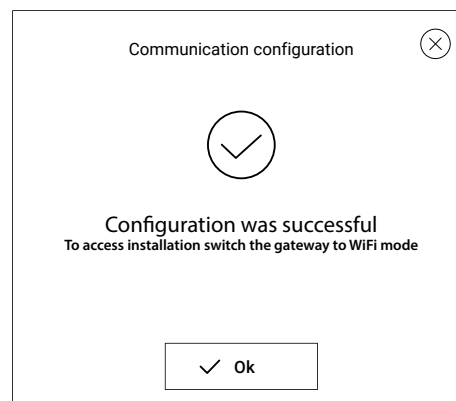

- ▶ **Enter** or **paste** the password from **the mobile application** and **click** the **Confirm** tile.

- ▶ Once the correct **token** has been entered, confirmation of correct registration will be displayed..  
By accepting the **OK** tile, the first installation element will appear.

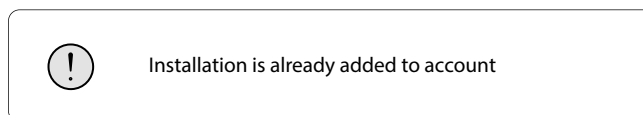

**Caution:** If you see the notification *Installation is already assigned to account*, please contact your supplier.

**12** Wentilo Installation Assistant - step 6 Entering WiFi network data**iCONNECT PRO**

- ▶ Proceed to step 6 by **clicking Next**. The **Device network settings** window will be displayed. In this window, **define** the **SSID** and **WiFi network password**.
- ▶ The **SSID** of the network can be found by clicking the icon  and **selecting** the appropriate network from the list.
- ▶ A password suitable for the selected network can be entered by clicking the icon .
- ▶ After entering the **SSID** and password, you can proceed to the next step by **clicking Next**.

**13** Wentilo Installation Assistant - step 7 Switching the panel to WiFi mode

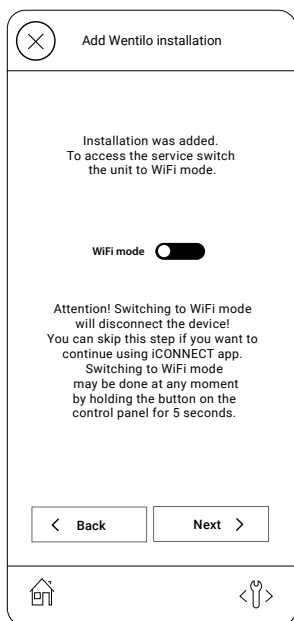

**iCONNECT PRO**

- ▶ After step 6, a window should appear to switch the panel to **WiFi mode**.
- ▶ Switch the iSWITCH Ti panel from the currently used **BT mode** to **WiFi mode** to connect to the network.
- ▶ In order to switch to **WiFi mode** after completing the adding of installation process, **activate** the **WiFi mode** switch located in the middle of the screen.
- ▶ You can end the process of adding the installation by **clicking** the **Finish** button. A screen will appear informing you of the end of the adding of installation process, followed by a note that the connection to the device has been lost.
- ▶ The LED on the panel next to the symbol will switch to a continuous light signal.

**Note:** switching to WiFi mode will cause the iCONNECT PRO application to lose connection with the control panel. You can turn on BT mode again by holding down the button on the iSWITCH Ti panel for 5 seconds. 



**3.3.3 Adding an installation component**

Once the iSWITCH Ti panel has been correctly configured as described in section 3.3.2 *Adding the iSWITCH Ti panel to the user account*, the installation component (Wentilo heat recovery unit) can be added to the user account. This process is described below for the iCONNECT mobile application.

**iCONNECT**

**1** Adding an installation component

- ▶ **Open** the iCONNECT mobile app and then select the correct installation from the list of installations by **clicking Open**.

**Note:** the status on the app screen should be **ONLINE**. If the installation is **OFFLINE**, verify the panel's network connection.

**Hint:** the installation list can be refreshed by swiping on the screen from the top down.

- ▶ This will open the page **adding a component to the installation**, i.e. the Wentilo heat recovery unit. To do this, **click** the **New installation component** tile, then **select** the ventilation controller and **confirm** the selection with the **Accept** button.

**An installation consisting of two components will be created:**

- an internet gateway (iSWITCH Ti panel)
- ventilation controller (main control board of the Wentilo heat recovery unit)

**2** Completion of the contact information

- ▶ Once the installation components have been added to the User account, contact details can be completed to help identify the installation.

**Hint:** **Installation name** will be displayed on the top bar of the user application home screen, helping to identify the system.

**3** Returning to menu

- ▶ Once you have completed your contact details, you can return to the home screen by **expanding** the Menu list in the top right corner . In the menu, click **Home**, which will open the main screen of the user application.

**Hint:** **Clicking** the icon  in the middle of the upper part of the screen will open the list of the main parameters of the heat recovery unit, i.e. temperatures, ventilation intensity, the degree of filter contamination etc. The amount of information displayed depends on installed and active components working with the heat recovery unit within the whole ventilation system.





When the heat recovery unit is switched on, the start screen is initially displayed, where the button:

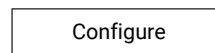

Takes you to the device configuration screen. Access protected by installer password.

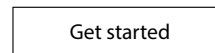

Takes you to the home screen.



Takes you directly to the Language selection menu.

### 3.4 iSENSE 5i control panel

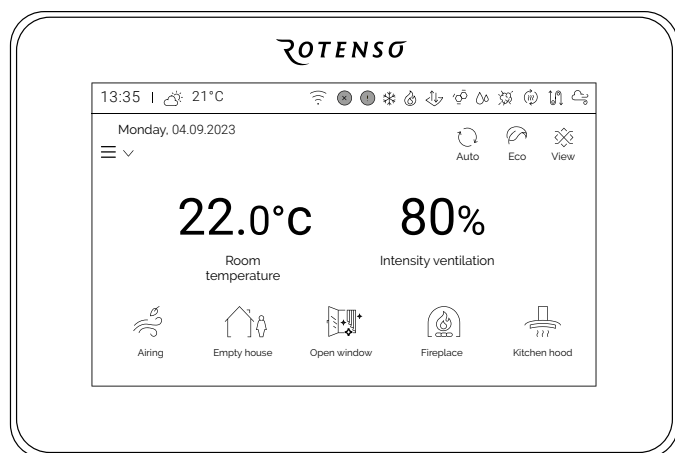

The iSENSE 5i control panel is equipped with a colour touchscreen. The Panel allows direct changes to all parameters of the unit. Built-in WiFi and BT modules also enable the heat recovery unit to be controlled via the iCONNECT mobile app or via the iCONNECT WEB service. The integrated temperature sensor allows the heat recovery unit to match the conditions of the room in which the iSENSE 5i panel is installed.

#### 3.4.1 Switching the heat recovery unit on



If start window remains idle for 30 s, panel will automatically switch to the home screen.

The start window can only be reopened after a power reset of the heat recovery unit.

#### 3.4.2 Adding the iSENSE 5i panel to the user account

Adding the iSENSE 5i panel to a user account can be done using the iCONNECT mobile application. Before configuring the iSENSE 5i panel, follow the steps described in section 3.2 *Create user account in the iCONNECT mobile application.*

If you experience problems with the configuration in **BT mode**, you can use the **configuration in manual mode**.

#### Configuration in BT mode

##### 1 Preparation of the iSENSE 5i panel

The iSENSE 5i control panel must be switched to BT mode. In order to do this, follow the steps below:

- ▶ On the main screen, **click** to the user menu icon ≡ ∨ (left side of the screen) and then **/Settings/WiFi**
- ▶ From the **WiFi settings** screen, **select BT mode** by **clicking** the **Mode** tile until the **BT** option is highlighted.

##### 2 Logging

- ▶ **Open** the iCONNECT app, then **enter** the email address and password you provided when registering your account and **click Login**.

**3** Creating an installation account

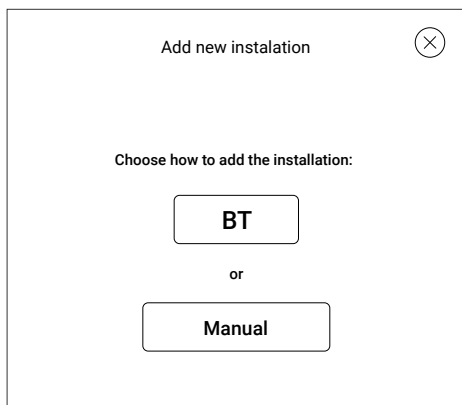

- ▶ After logging in, the **Choose installation** window appears. **Click** the **Add** tile. This will open the **Add new installation** window.
- ▶ User has two options to choose from: **BT** and **Manual**. **Select BT mode**, which automatically detects iSENSE 5i control panels in the vicinity operating in BT (acting as an internet gateway).  
**Note:** in case of problems with the connection in this mode, use the **configuration in manual mode** instruction.

**4** Connecting to the panel

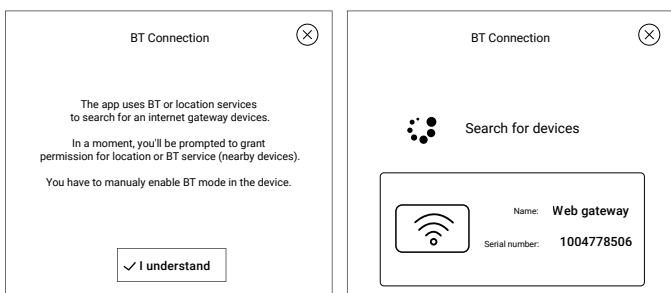

- ▶ User must allow the application to access the location in order to search for nearby devices.
- ▶ When the iSENSE 5i panel (a nearby device) is found, the application informs you with an appropriate message.
- ▶ **Click** the internet gateway tile, confirming that the appropriate device has been selected.

**5** Acceptance of consents

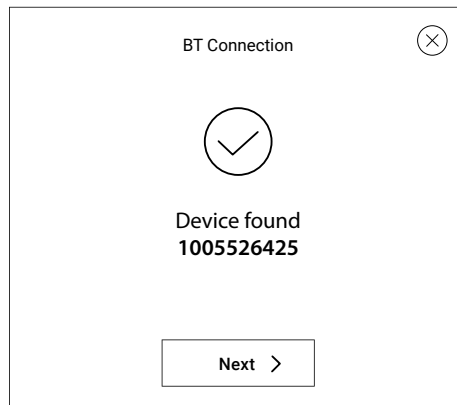

- ▶ Once the device has been selected, a new screen will appear to confirm that communication has been established.
- ▶ **Click Next**. This will open the **Marketing agreements** window. You will need to **grant access** to your personal data and **accept** all necessary statements and optionally marketing consents.

**6** Choice of installation name

- ▶ You need to **define** the **Installation name**, which will be visible in the iCONNECT mobile app and the iCONNECT WEB service. The **name** can be anything you like. After **entering** the name, confirm it by **clicking** the **Add** button.  
**Caution:** If you see the notification *Installation is already added to account*, please contact your supplier.

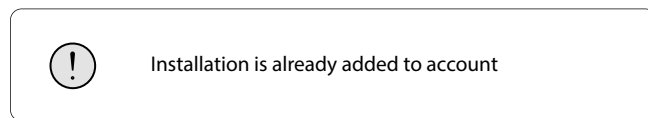

**7** WiFi configuration

- ▶ User should see the **WiFi Configuration** pop-up. **Select Yes** to begin configuring the iSENSE 5i panel WiFi module.
- ▶ **Enter** the **SSID** of the WiFi network and the **password** with which the network is encrypted. Then **click Accept**. Message should appear informing you that the WiFi configuration has been correctly completed.
- ▶ The iSENSE 5i panel will switch to WiFi mode. Once the panel is successfully connected to the WiFi network, you can proceed to the process of adding an installation component as described in section 3.4.3 *Adding an installation component*.  
**Note:** the message *Waiting time for the device to respond has been exceeded* may be displayed, indicating that the panel has been switched to WiFi Mode.  
**Note:** WiFi connection is indicated by a steady light next to the icon 
- ▶ **Hint:** if the connection is not successful, follow the section on **changing WiFi settings**.

**8** Changing WiFi settings

- ▶ If you enter an incorrect network **SSID** or **password**, **switch** the panel to **BT mode** (see section *Preparation of the iSENSE 5i panel*).
- ▶ Next, in the iCONNECT application, select the installation by **clicking** the **Select** button and then **click WiFi settings**.
- ▶ Allow the application to access the location so that it can search for devices in the vicinity.
- ▶ Once the iSENSE 5i panel is found, the application informs you with an appropriate message.
- ▶ **Click** the internet gateway tile, confirming the selection of the appropriate device.
- ▶ After a successful connection, the **WiFi configuration** window opens where you can overwrite your network settings. Once the changes have been made, **click Accept**. The iSENSE 5i panel will automatically enter WiFi mode.

**Configuration in manual mode**

**1** Open WiFi settings

- ▶ On the main screen of the iSENSE 5i panel, **click** the user menu icon ≡ ∨ (left side of the screen) and then **/Settings/WiFi**

**2** WiFi settings screen

The **WiFi settings** screen is divided into four tiles.

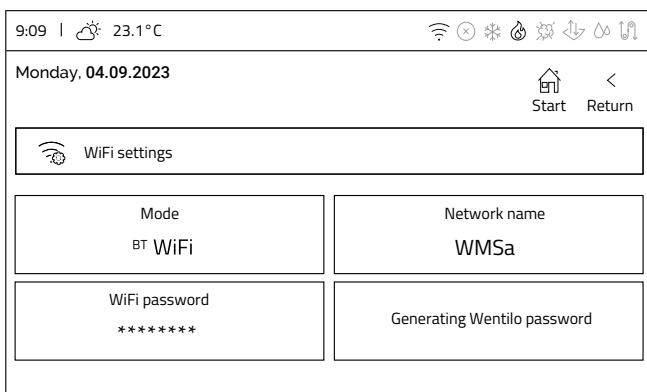

- **Mode** - indicates the communication mode. Clicking switches between BT and WiFi modes.
- **Network name** - clicking opens an on-screen keyboard that allows you to enter the name of your WiFi network.
- **WiFi password** - clicking opens an on-screen keyboard that allows you to enter the name of your WiFi network.
- **Generating Wentilo password** - clicking opens the window for generating the password (token) required to add a new installation to the user account.

**3** WiFi configuration

**WiFi configuration requires three steps:**

- 1** Switch the panel to **WiFi mode** by **clicking** the **Mode** tile until the **WiFi** option is highlighted.
- 2** **Enter** the **network name** using the on-screen keyboard by **clicking** the **Network name** tile.
- 3** **Enter** the **WiFi password** using the on-screen keyboard by **clicking** the **WiFi password** tile.

**Note:** Once the appropriate network configuration settings have been entered, the following signal appears on the top information bar: . The panel needs several seconds to establish a connection to the WiFi network. The appearance of the WiFi icon on the top information bar indicates a correct connection to the network.

**4** Logging

- ▶ **Open** the iCONNECT app, then **enter** the email address and password you provided when registering your account and **click Login**.

**5** Creating an installation account

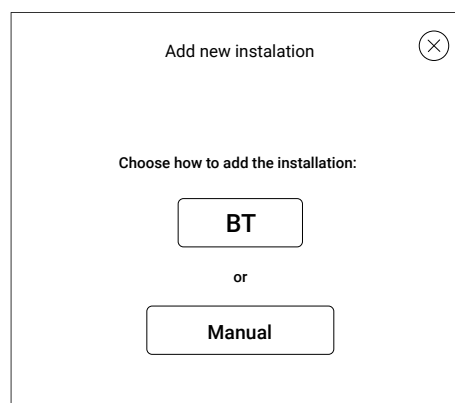

- ▶ After logging in, the **Choose Installation** window appears. **Click** the **Add** tile. This will open the **Add new installation** window.
- ▶ User has two options to choose from: **BT** and **Manual**. **Manual mode** should be selected.

**6** Choice of installation name

**iCONNECT**

- ▶ You must **define** the installation **name** that will be visible in the iCONNECT mobile app and the iCONNECT WEB service. The **name** can be anything you like.
- ▶ Then **enter** the **serial number** read from the iSENSE 5i panel as per the instructions below.
- ▶ Once the **Serial number** field has been completed, you can proceed to the next step by **clicking Next**. This will open the **Marketing agreements** window. You must **grant access** to your personal data and **accept** all necessary statements and optionally marketing consents.
- ▶ User will be asked to enter a **password** from the **mobile application (token)**, which is generated in the next step.

**iSENSE 5i - serial number**

- ▶ Enter settings for **Generating Wentilo password**. In order to do so:

- 1** **Click** the screensaver, which opens the home screen.
- 2** Open the menu by **clicking** the ≡ ∨ icon and then **/Settings/WiFi**
- 3** **Select** **Generating Wentilo password**

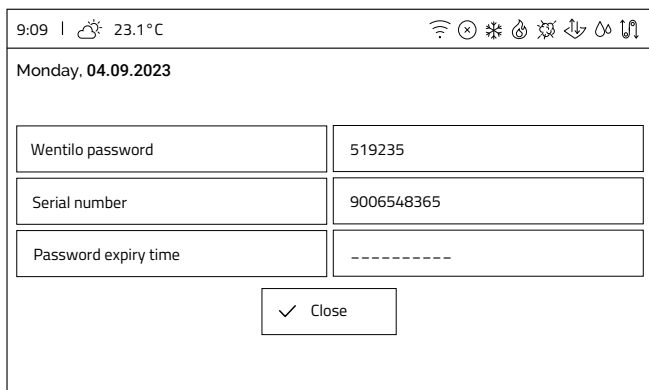

- ▶ A screen opens presenting three options:
  - 1** **Wentilo password (Token)**, which is automatically generated in real time every approx. 1 minute, without any user intervention.
  - 2** **Serial number** of the iSENSE 5i panel.
  - 3** **Password expiry time** which specifies the time until the **token** is changed.

**7** Token generation

**iCONNECT**

- ▶ **Enter** the **Wentilo password, (token)** and then **click Accept**. The token can be obtained by following the steps in the instructions below.
- ▶ Window will appear confirming that the configuration has been performed correctly. Confirm by **clicking** the **OK** button.
- ▶ **Caution:** If you see the notification *Installation is already added to account*, please contact your supplier.

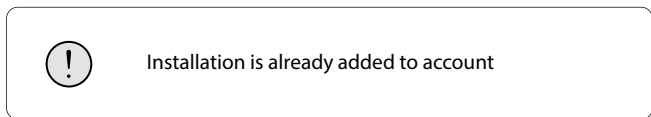

**iSENSE 5i - generating token**

- ▶ You must enter the **Generating Wentilo password** setting. In order to do so:
  - 1** **Click** the Screensaver, which opens the home screen.
  - 2** **Open** the menu by **clicking** the ≡ ∨ icon and then **/Settings/WiFi**
  - 3** **Select** **Generating Wentilo password**
  - 4** **Enter** the **Wentilo password** into the iCONNECT application.

**3.4.3 Adding an installation component**

Once the iSENSE 5i panel has been correctly configured as described in section 3.4.2 *Adding the iSENSE 5i panel to the user account*, the installation component (Wentilo heat recovery unit), can be added to the user account. This process is described below for the iCONNECT mobile application.

**1** Adding an installation component

- ▶ **Open** the iCONNECT mobile app and then select the correct installation from the list of installations by **clicking Open**.
 

**Note:** the status on the app screen should be **ONLINE**. If the installation is **OFFLINE**, verify the panel's network connection.

**Hint:** the installation list can be refreshed by swiping on the screen from the top down.

- ▶ This will open the page **adding a component to the installation**, i.e. the Wentilo heat recovery unit. To do this, **click** the **New installation component** tile, then **select** the ventilation controller and **confirm** the selection with the **Accept** button.

**An installation consisting of two components will be created:**

- an internet gateway (iSENSE 5i panel)
- ventilation controller (main control board of the Wentilo heat recovery unit)

**2** Completion of the contact information

- ▶ Once the installation components have been added to the User account, contact details can be completed to help identify the installation.

**Hint: Installation name** will be displayed on the top bar of the user application home screen, helping to identify the system.

**3** Returning to menu

- ▶ Once you have completed your contact details, you can return to the home screen by **expanding** the Menu list in the top right corner . In the menu, click **Home**, which will open the main screen of the user application.

**Hint: Clicking** the icon  in the middle of the upper part of the screen will open the list of the main parameters of the heat recovery unit, i.e. temperatures, ventilation intensity, the degree of filter contamination etc. The amount of information displayed depends on installed and active components working with the heat recovery unit within the whole ventilation system.



**3.4.4 Home screen**

The home screen is the primary screen for the user. It consists of four parts:

- information elements,
- operation modes tiles,
- main values tiles,
- momentary operation modes tiles.

**Information elements**

13:35 | ☁ 21°C





Monday, 04.09.2023

In the top left corner of the screen you will find information about the current temperature of the outdoor air sensor, the set date and time of the heat recovery unit.



In the top right corner of the screen there is a bar indicating the operating status of the heat recovery unit. The various indications are explained later in this manual.

**Explanation**

	WiFi
	alarm
	cooling
	heating
	air quality sensor
	GHE
	humidity sensor
	bypass

**Operation modes tiles**



There are interactive buttons below the status bar.

The first position from the left switches the operation mode of the heat recovery units.

**The available modes are:**



**Auto**, in this mode the heat recovery unit monitors the air quality using dedicated sensors and adjusts the fans control based on the readings.



**Manual**, in this mode the flow rate of the fans can be freely set.



Schedule

**Schedule**, in this mode the Fans operate according to a pre-programmed schedule, depending on the gears configured. Any heat recovery unit flow rate can be assigned for a given gear.

Position two allows you to switch between the operating modes of the complementary devices.

**The available modes are:**



Comfort

**Comfort**, in this mode the heat recovery unit uses additional components to regulate the supply air temperature to the comfort temperature (complementary devices: secondary heater, cooler, condensing unit).



Eco

**Eco**, in this mode the heat recovery unit does not use additional components to regulate the supply air temperature to the comfort temperature in order to save electricity.

Position three allows the status of the heat recovery unit to be monitored:



View

**View** takes you to the heat recovery unit diagram presentation screen, where you can monitor the current status of the individual components.

**View diagram of the heat recovery unit**

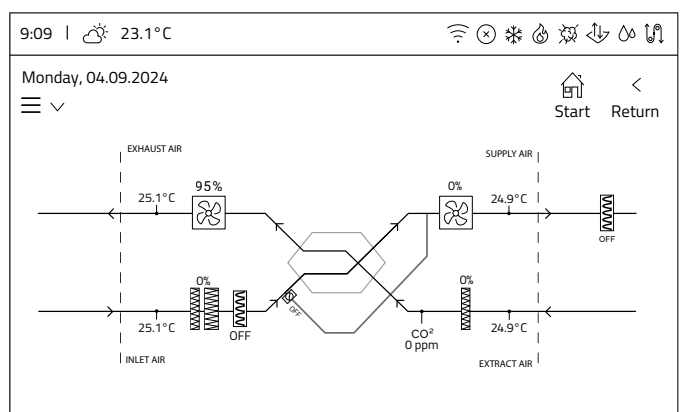

**Main values tiles**

23.1°C 50%  
 Temperature room Intensity ventilation

The centre of the display shows two main pieces of information about the operation of the heat recovery unit: **room temperature** and **ventilation intensity**.

23.1°C  
 Temperature room

The **room temperature** tile displays the current measured room temperature. The area is only clickable if additional supply air temperature controls are configured. After clicking the area, the user will be taken to a window with the option of setting the comfort temperature as day (for a description of the temperature for day, see the section on temperature schedules).

50%  
 Intensity ventilation

The **ventilation intensity** tile displays the current fans control. Clicking this area takes the user to the window for setting ventilation intensity. The format of the presented unit (% or m3/h) depends on the type of heat recovery unit airflow control.

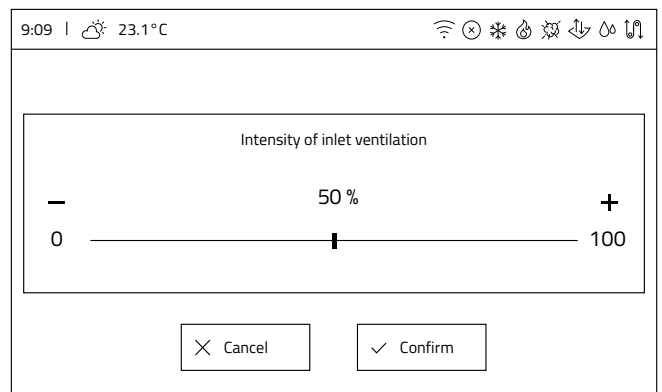

Heat recovery unit with **iEDGE** control system - ventilation intensity will be presented in %

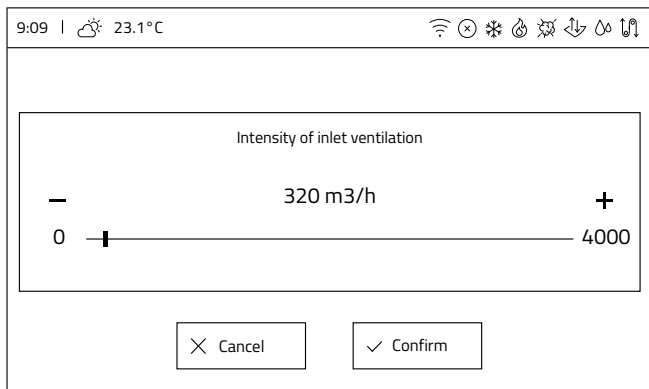

Heat recovery unit with **IEDGE SMART** control system - ventilation intensity will be presented in m3/h.

### Momentary operation modes tiles

At the bottom of the screen are icons for quick activation of **momentary operation modes**. Pressing the icon activates a time mode (only one time mode can be active at a time). Momentary operation modes available are:



Airing

**Airing**, the heat recovery unit operates with increased fan power for a set duration to quickly ventilate the rooms.



Empty house

**Empty house**, switches off the heat recovery unit for the time the user leaves the room/building. It is possible to set the date and time for the mode to be switched on in advance, as well as for the airing function to be switched on/off.



Open window

**Open window**, mode to assist the flow of outside air through the window. Supply fan control is set to a preset value expressed as a percentage and the extract fan control is stopped.



Fireplace

**Fireplace**, turning on the fireplace function increases the power difference between the supply fan and the exhaust fan by their intensity value set by the user, for the set duration. This creates a positive pressure in the house to improve the chimney draught.



Kitchen hood

**Kitchen hood**, mode allows the air extracted by the kitchen hood to be balanced, whereby the supply fan power is increased and the Extract fan flow rate is reduced to a user-set value.

### 3.4.5 Menu

When the menu icon  $\equiv \checkmark$  is clicked on the home screen, the user is taken to the user menu window.

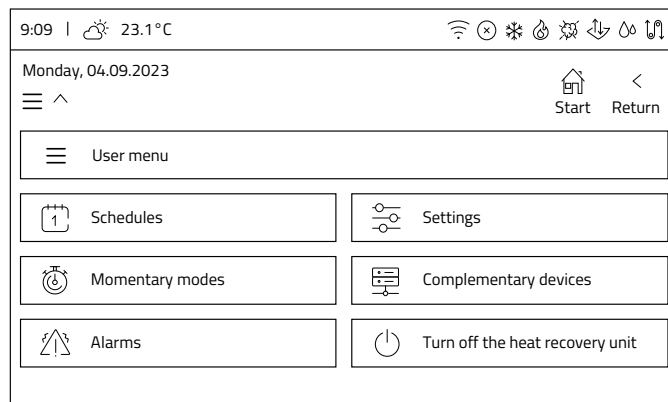

The user menu contains 6 active buttons, 5 of which take you to successive screens containing further submenus or information, and the last switches the heat recovery unit off/on:

- Schedules
- Momentary modes
- Alarms
- Settings
- Complementary devices
- Turn off the heat recovery unit

### 3.4.6 Schedules

Selecting the Schedules button in the Menu takes you to the Schedules submenu, where you can select a schedule for editing from the two available:

- Ventilation intensity schedule
- Temperature schedule

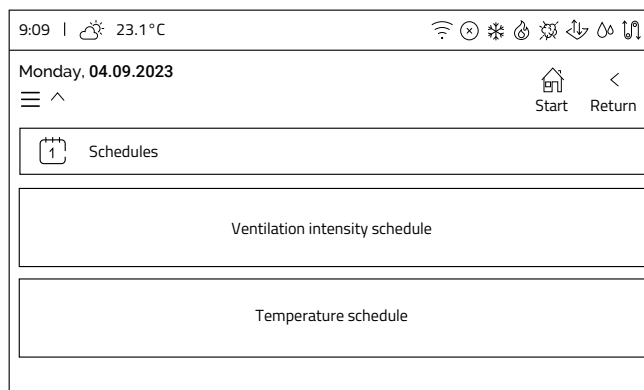

### 3.4.6.1 Ventilation intensity schedule

#### 1 Ventilation intensity schedule screen

- Once the **Ventilation intensity schedule** has been selected, the user is redirected to a screen with a selection of days of the week, where individual ranges can be set by schedule for each day of the week separately.

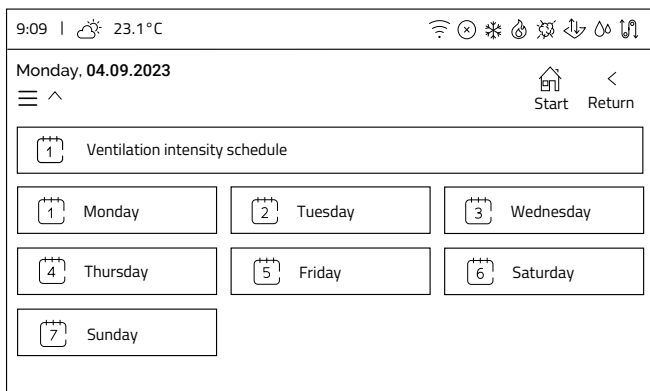

#### 2 Day edit screen

- After selecting the days of the week, you will be redirected to a screen with a choice of editing **4 time intervals**.

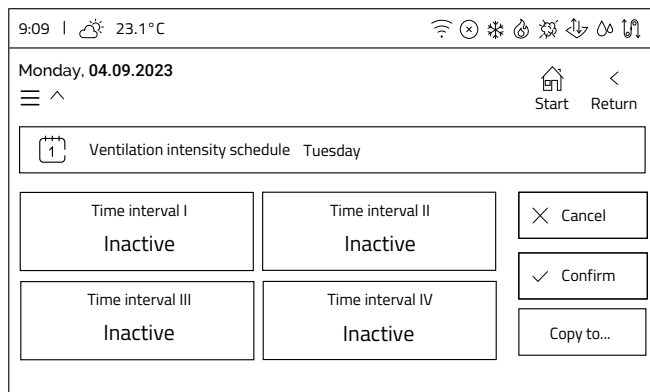

#### 3 Screen for editing the time interval

- Once the time interval has been selected, an **editing window** will be displayed.

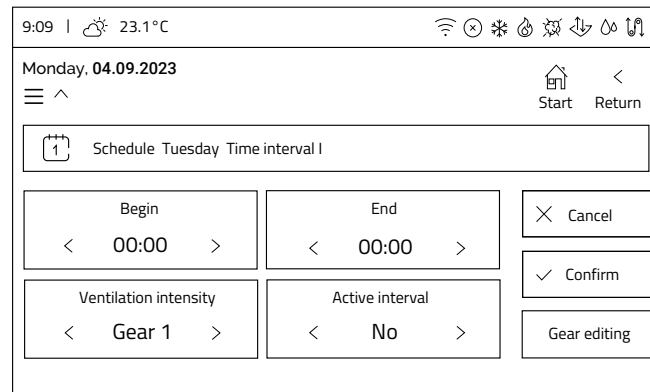

#### 4 Time interval edit

- 1 Activate** the interval (bottom right **Active interval** - set to **Yes**).

Once activated, the **Begin**, **End** and **Ventilation intensity** options are unlocked.

- 2** Set the start time of the interval by **clicking** the **Begin** tile. Edit can be made by **clicking** the arrows (**< -30min; > +30min**) or by **clicking** a numerical value, then a screen will be displayed where we can set a specific time in the range from 0 to 23 and minutes in the range 00 or 30.

- Similarly, **set** the **End** of the interval.

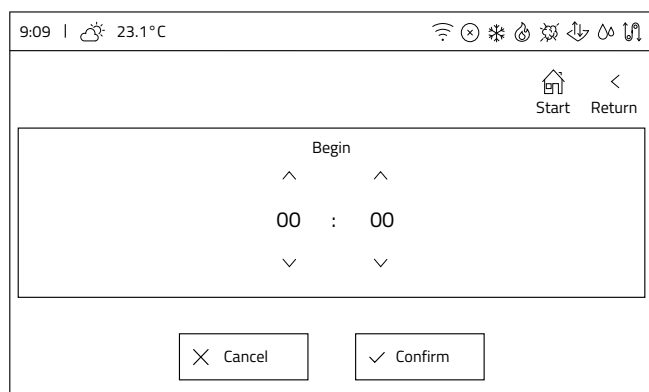

- 4 Ventilation intensity** assigned to a time interval is changed by using the **< ; >** arrows, selecting between **Gear 1, Gear 2, Gear 3, Pause**

- After setting the interval, **click Confirm**. Similarly, **set** the other ranges for the day (you can set all four ranges or less).

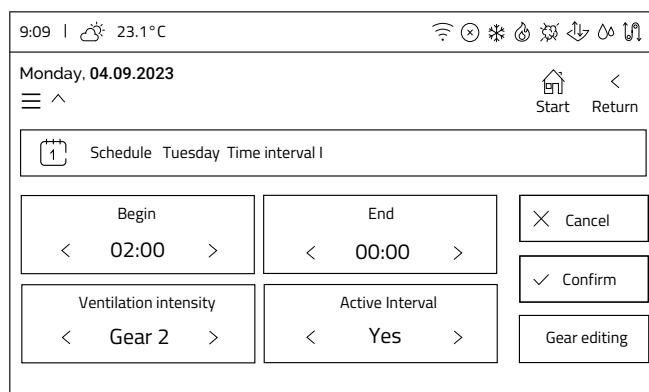



**5** Gear editing

- ▶ From the **time interval** screen, you can go to edit the **Ventilation intensity** for a particular gear by **clicking** the **Gear editing** button. This will open the **Gear settings** window.

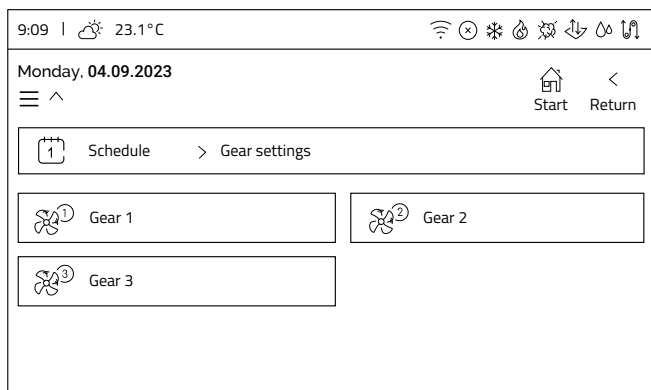

- ▶ Once a gear has been **selected**, the **Fans control** window for that gear opens.

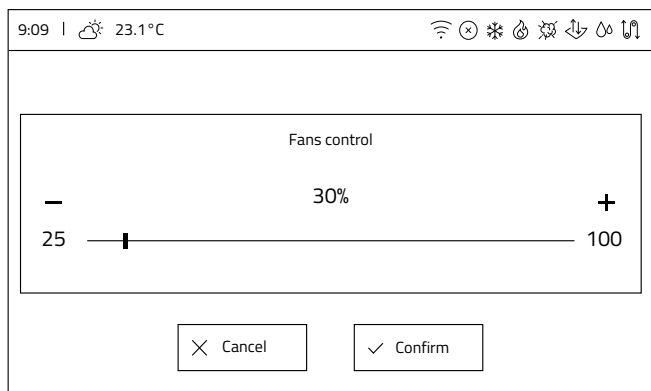

**6** Confirmation of the schedule for a particular day

- ▶ When you have finished editing the schedule for a particular day, **confirm** the data you have entered with the **Confirm** button.
- ▶ If all the intervals are correct, a window will appear where you **accept** the **schedule changes**.

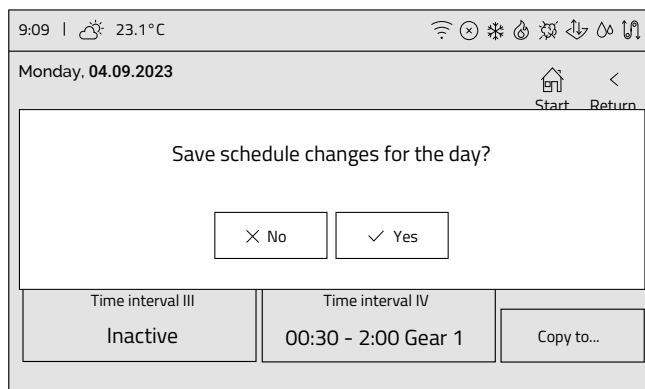

- ▶ If the heat recovery unit detects **an error of overlapping time interval**, it screen with the message will be displayed and will prevent the wrong schedule from being saved.

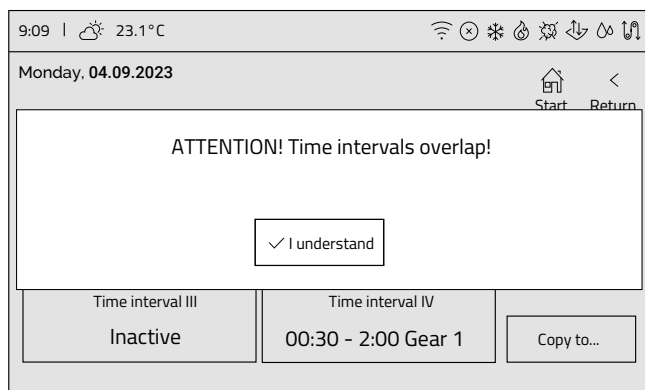

- ▶ You must then **go back** to edit the ranges, **correct** the overlapping time intervals and **reconfirm** the data entered.

**7** Copying schedules

Schedules for each day are edited in the same way. If the schedules are the same for other days of the week, it is possible to copy the set schedule to other days. To do this, in the editing window of the set and saved schedule for a given day, **click** the button **Copy to ...**, which will open a window with the selection of days of the week. Select the days to which a correctly configured schedule will be copied and then **click** the **Copy** button.

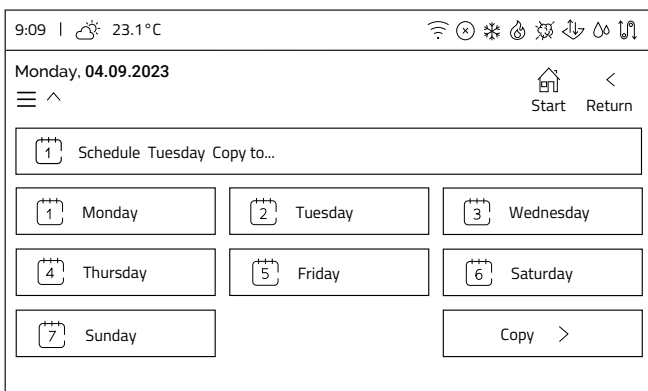

- ▶ Once the heat recovery unit settings have been copied, the window confirming the schedule changes for that day will appear again.

### 3.4.6.2 Temperature schedule

Once the temperature schedule have been selected, the user is redirected to a selection screen:

**1** Temperature schedule screen

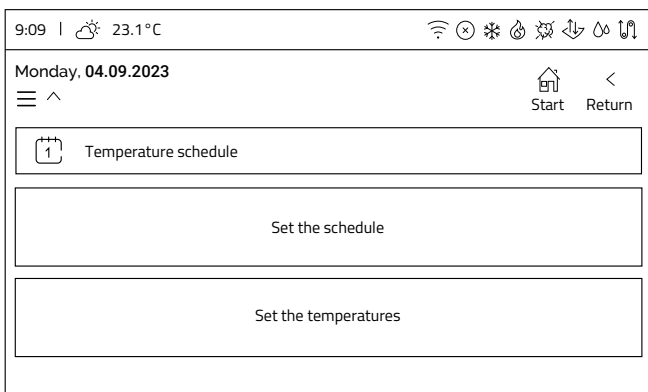

- ▶ **Set the schedule** - where you set the schedule intervals.
- ▶ **Set the temperatures** - where daytime temperature and nighttime temperature (time reduction) are set.

**2** Set the temperatures screen

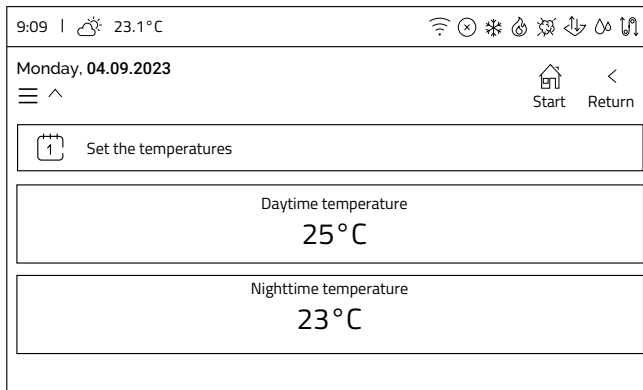

- ▶ After selecting **Set the temperatures** from the **Temperature schedule** menu, the user will be taken to the **Set the temperatures** window, where two temperature settings can be defined: **daytime temperature** and **nighttime temperature**, which can then be used for **temperature schedule** settings.

- **daytime temperature** - is the temperature that will be maintained by default by the heat recovery unit when the comfort operation mode is active.

**Note:** Unit must be equipped with complementary devices for proper comfort mode operation.

- **nighttime temperature** is the temperature that will be maintained for the time reduction in the temperature schedules.

**Hint:** instructions for setting the time reduction are included in the following steps.

- ▶ The setting can be changed by **clicking** the tile for the temperature in question, and then setting the desired value using the **+** and **-** buttons. Then **confirm** the setting with the **Confirm** button.
- ▶ Once the settings are complete, you can return to the **Temperature schedule** window with the **Return** button.

**3** Selection of days of the week

► When the **Set the schedule** tile is **selected**, the user is taken to a screen with a selection of days of the week, where different temperature setting can be specified for each day separately.

The principle of temperature schedule settings is similar to ventilation intensity schedule.

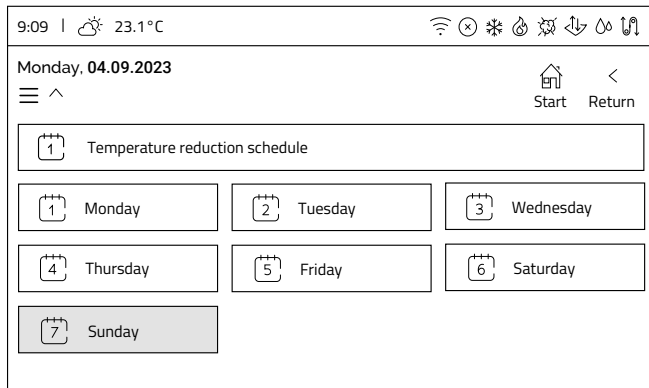

**4** Day edit screen

After selecting a specific day of the week, the screen will be displayed with the possibility of setting **4 time intervals** in which the **nighttime temperature** will apply.

**Noe:** By default the schedule is set to nighttime temperature i.e. on each day of the week the Time reduction interval I is active for the entire day (00:00 - 00:00).

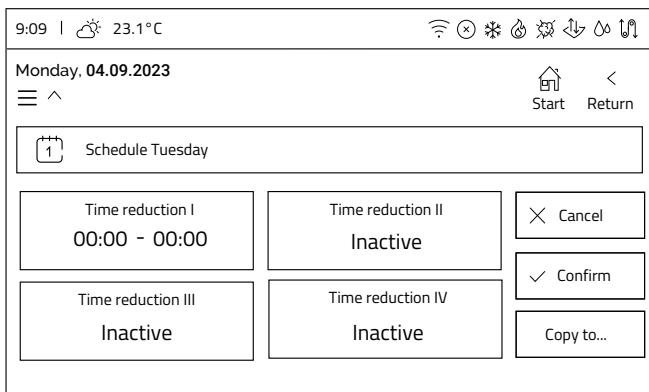

**5** Time reduction editing screen

► Once a time reduction has been **selected** an editing window will be displayed.

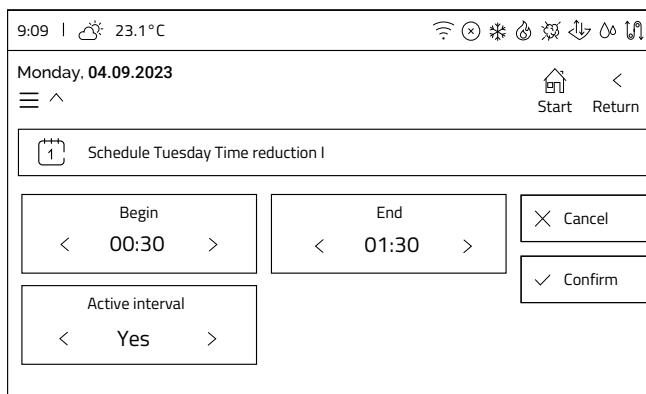

**6** Time reduction edit

**Note:** The reduction temperature (nighttime temperature) is set in the intervals, the daytime temperature applies for the rest of the time between the intervals.

- 1** The interval must be activated (bottom right key **Active interval** - set to **Yes**). Once activated, the **Begin** and **End** options are unlocked.
- 2** Set the **Begin** time of the interval by **clicking** the **Begin** tile. Editing can be made by **clicking** the arrows (**< -30min; > +30min**) or by **clicking** a numerical value, then a screen will be displayed where we can set a specific time in the range from 0 to 23 and minutes in the range 00 or 30.
- 3** Similarly, set the **End** of the interval.
- 4** Once the interval is set, **click Confirm**. Similarly, set the other intervals for the day (you can set all four intervals or less).

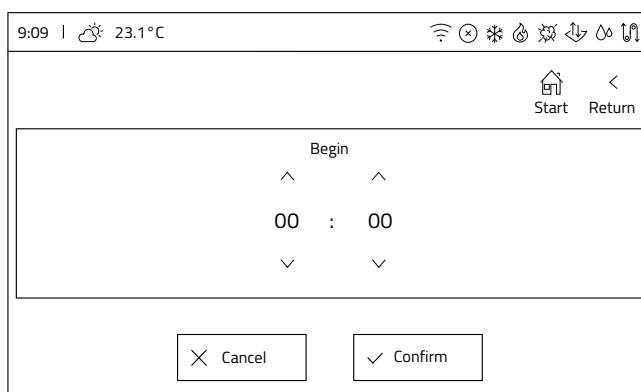

**Note:** There is no verification of overlapping intervals in temperature schedules. If, during editing, you set ranges whose time intervals overlap, the control panel automatically combines them to form one common range.

**7** Example of a day with set time reduction

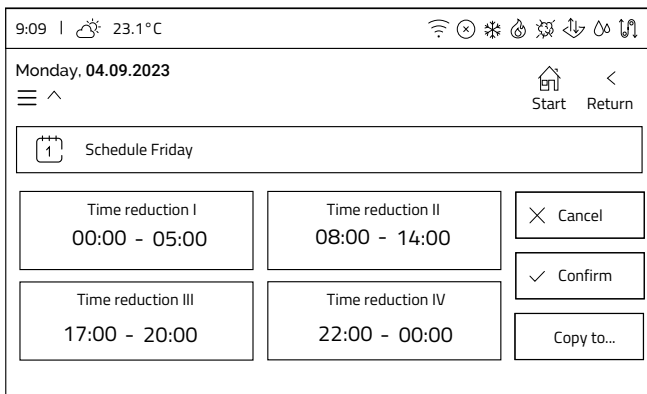

**This screen shows the set four ranges of reduction**

1. **Time reduction I** (00:00 - 05:00)  
Nighttime temperature (bedtime) will be in this interval.
2. **Range between intervals** (05:00-08:00)  
Daytime temperature range (preparation for going out).
3. **Time reduction III** (08:00 - 14:00)  
Nighttime temperature will be in this range (everyone away from home, no need for higher temperatures).
4. **Range between intervals** (14:00-17:00)  
Daytime temperature range (return from work, school).
5. **Time reduction III** (17:00 - 20:00)  
Nighttime temperature (shopping, after-school activities).
6. **Range between intervals**(20:00-22:00)  
Daytime temperature range (evening activities at home).
7. **Time reduction IV** (22:00 - 00:00)  
nighttime temperature compartment (bedtime).

**8** Confirmation of the schedule for a particular day

- ▶ When you have finished editing the schedule for a particular day, confirm the data you have entered with the **Confirm** button. If all the ranges are correct, a window will appear where you accept the schedule changes.

**9** Copying schedules

Schedules for each day are edited in the same way. If the schedules are the same for other days of the week, it is possible to copy the set schedule to other days. To do this, in the editing window of the set and saved schedule for a given day, **click** the button **Copy to ...**, which will open a window with the selection of days of the week. Select the days to which a correctly configured schedule will be copied and then **click** the **Copy** button.

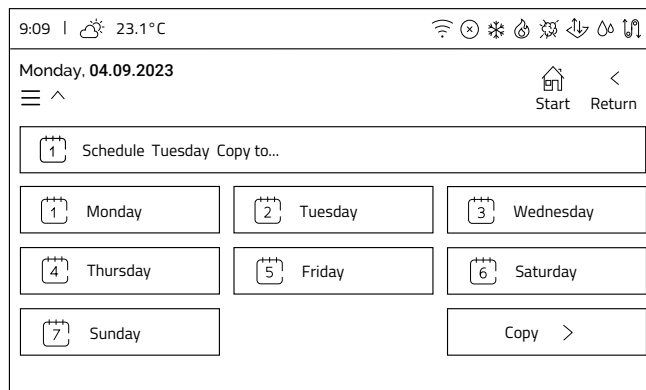

- ▶ Once the heat recovery unit settings have been copied, the window confirming the schedule changes for that day will appear again.

**3.4.7 Settings**

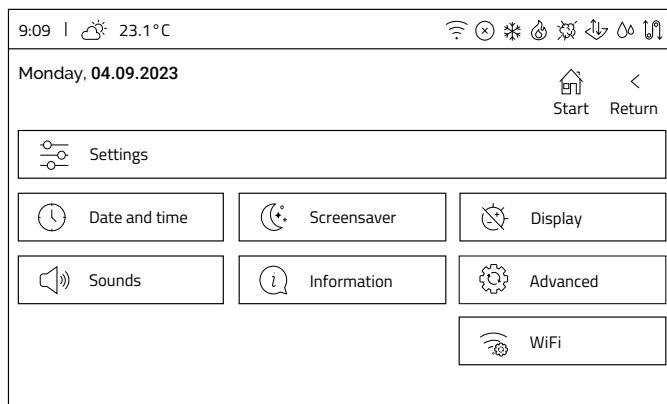

- ▶ When you click the **Settings** tile on the **User menu** screen, further items appear, which redirect you to the following windows presented in the following points.

**Screen elements:**

- Date and time,
- Screensaver,
- Display,
- Sounds,
- Information,
- Advanced\*,
- WiFi.

**\*Advanced settings are described in a separate chapter**

## Date and time setting

### 1 Date and time screen

- ▶ The **Date and time** screen opens by **clicking** the **Date and time** tile on the **Settings** screen.

The screen allows you to edit two parameters:

- Time
- Date

**Caution:** Setting the correct date and time is very important! It is according to this setting that the **schedules** work and the **alarms** are read, which then are archived in the web service and mobile app.

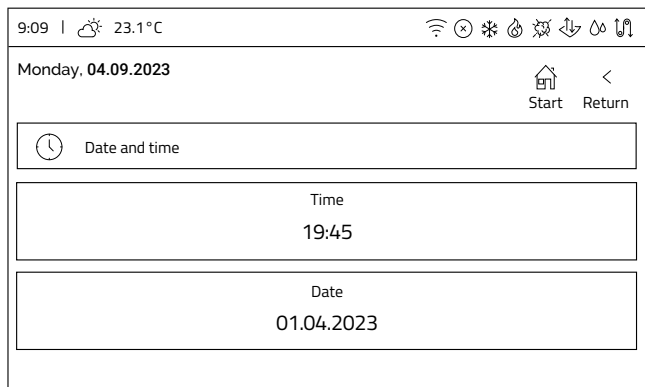

### 2 Edit parameters

- ▶ Settings are changed by **clicking** the relevant tile and then using the arrows to set the desired value. The change is confirmed with the **Confirm** button.

Date format is day : month : year

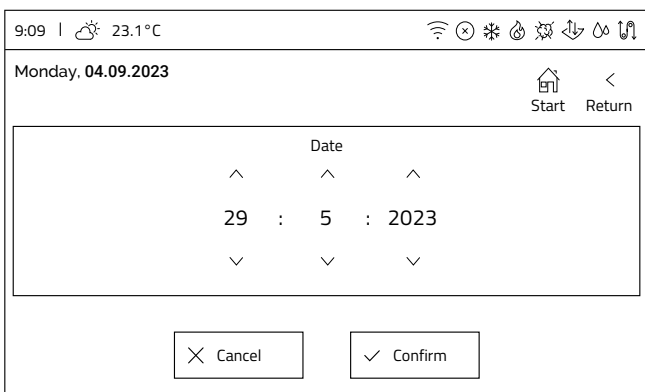

## Screensaver Settings

### 1 Screensaver screen

- ▶ The **Screensaver** screen opens by **clicking** the **Screensaver** tile on the **Settings** screen.

The screen allows you to edit two parameters:

- **Time to expire**, which determines after how long of inactivity the panel activates the screensaver
- **Backlight brightness of the screensaver**

**Hint:** Setting a value of 0% for the **Backlight brightness of the screensaver** parameter causes the screen to go out completely.

**Hint:** When you click the screensaver, the home screen is displayed.

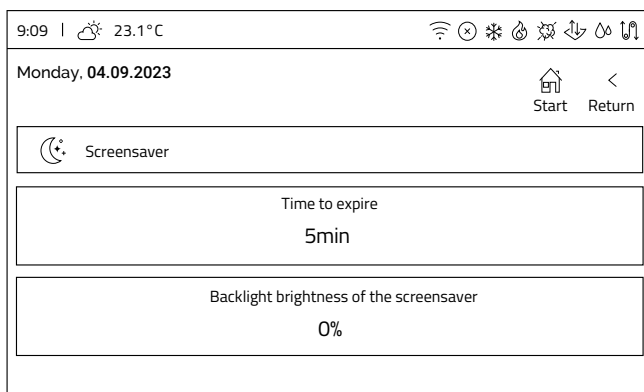

### 2 Edit parameters

- ▶ Settings are changed by **clicking** the relevant tile and then using the **+** and **-** buttons or by **clicking** the value axis to set the desired value. The change is confirmed with the **Confirm** button.

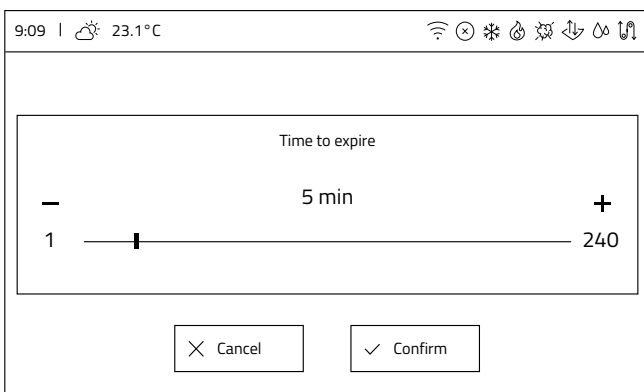

## Display Settings

### 1 Display screen

▶ The **Display** screen opens by **clicking** the **Display** tile on the **Settings** screen.

The screen allows you to edit a single parameter:

- **Screen brightness**

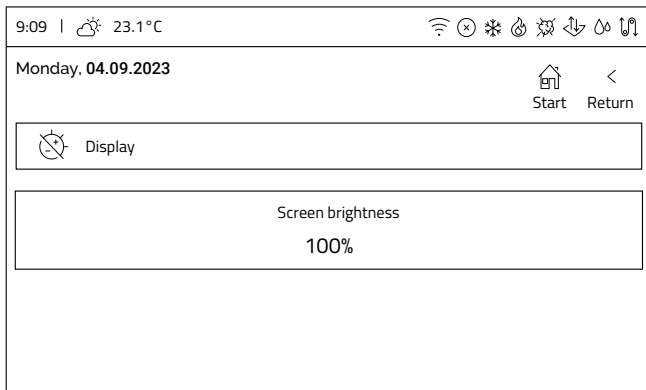

### 2 Edit parameters

▶ Settings are changed by **clicking** the relevant tile and then using the **+** and **-** buttons or by **clicking** the value axis to set the desired value. The change is confirmed with the **Confirm** button.

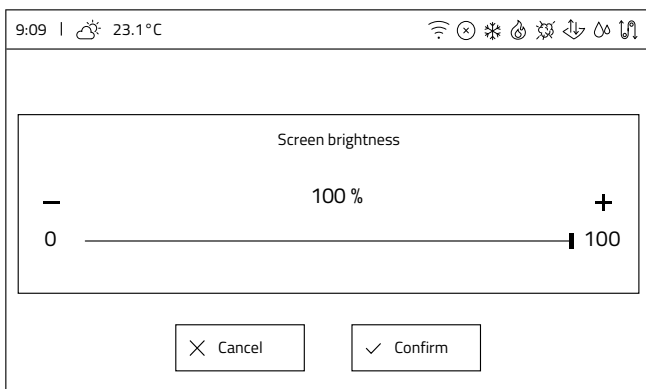

## Sounds settings

### Sound screen

▶ The **Sound** screen opens when you **click** the **Sounds** tile on the **Settings** screen.

The screen allows you to edit two parameters:

- Alarm sounds
- Buttons sounds

Both parameters are of the turn on/off type. The status is changed by **clicking** a tile. The current status is described and, with the active option, the tile is additionally highlighted.

### Sounds off

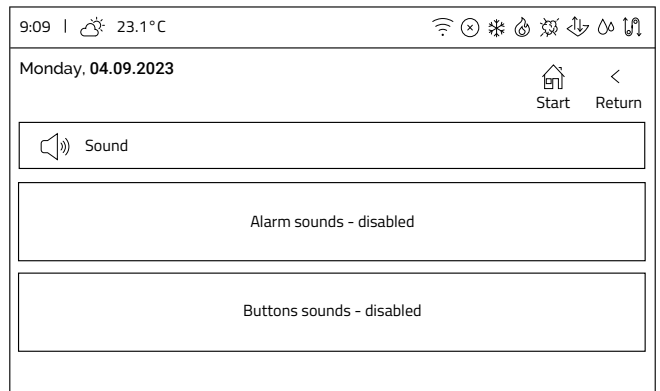

### Sounds on

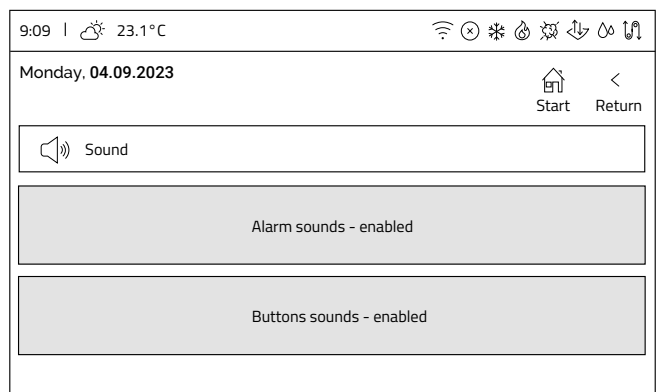

## Information

### Information screen

▶ The **Information** screen opens when you **click** the **Information** tile on the **Settings** screen. The screen allows you to check the following Informations:

- Device model
- Serial number iEDGE M 2.2
- Software version iEDGE M 2.2
- Software version iSENSE 5i

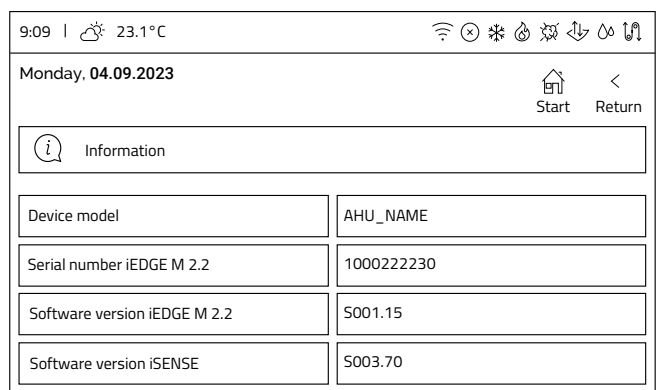

## WiFi settings

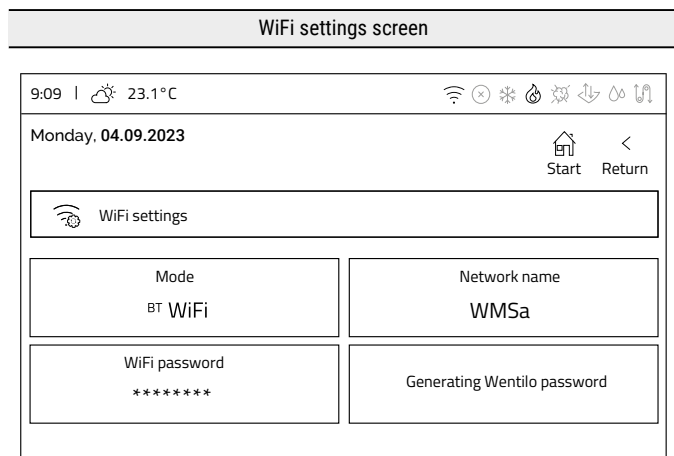

- **Mode** - indicates the communication mode. Clicking switches between BT and WiFi modes.
- **Network name** - clicking opens an on-screen keyboard that allows you to enter the name of your WiFi network.
- **WiFi password** - clicking opens an on-screen keyboard that allows you to enter the name of your WiFi network.
- **Generating Wentilo password** - clicking opens the window for generating the password (token) required to add a new installation to the user account.

### WiFi configuration

#### WiFi configuration requires three steps:

- 1** Switch the panel to **WiFi mode** by **clicking** the **Mode** tile until the **WiFi** option is highlighted.
- 2** **Enter** the **network name** using the on-screen keyboard by **clicking** the **Network name** tile.
- 3** **Enter** the **WiFi password** using the on-screen keyboard by **clicking** the **WiFi password** tile.

**Note:** Once the appropriate network configuration settings have been entered, the following signal appears on the top information bar: .

The panel needs several seconds to establish a connection to the WiFi network. The appearance of the WiFi icon on the top information bar indicates a correct connection to the network.

## Language settings

### Language screen

- ▶ The **Language** screen opens by **clicking** the **Language** tile on the **Settings** screen. Language is changed by **clicking** the appropriate tile. The tile with the currently selected language is highlighted.

**Note:** It takes a few seconds to change the language. During this time, the control panel will not respond to touch.

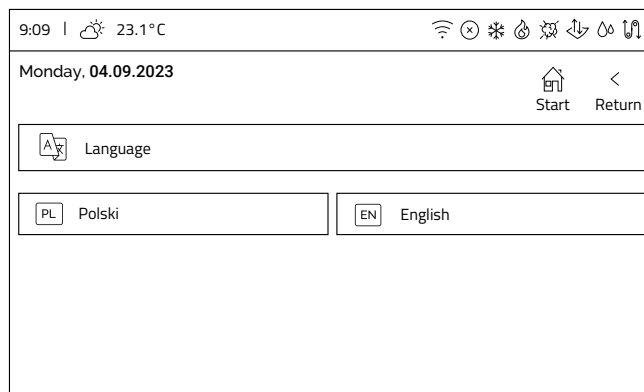

### 3.4.8 Momentary operation modes

The **Momentary modes** screen, opened from the **User menu**, presents all available Momentary operation modes. **Clicking** a mode's tile opens a window allowing the user to edit the mode's operating parameters settings.

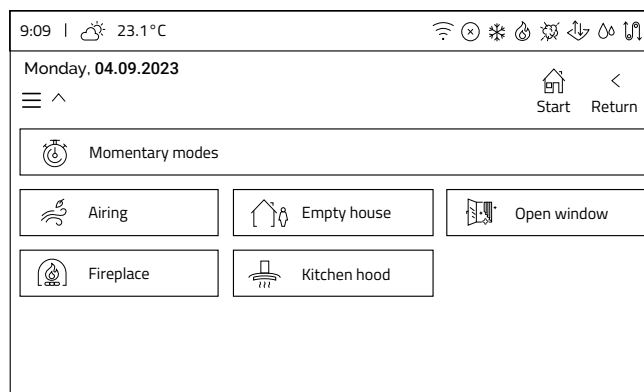

## Airing

### Airing screen

Momentary operation mode **Airing** has 2 or 3 parameters, depending on the settings made by the installer.

- **ventilation intensity**, or
- **intensity of supply ventilation** and **intensity of extract ventilation**

determine the fans control during operation of that mode. The parameter **Duration** specifies the duration of the mode.

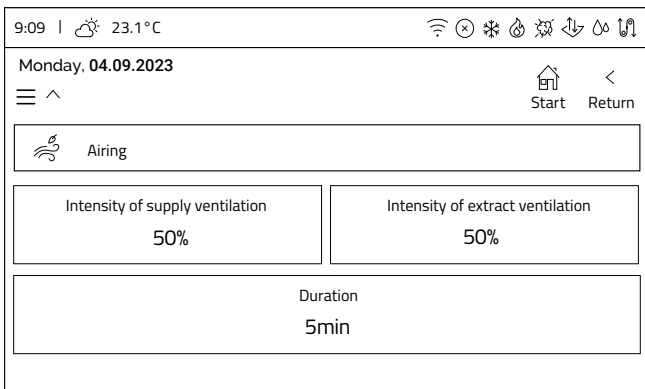
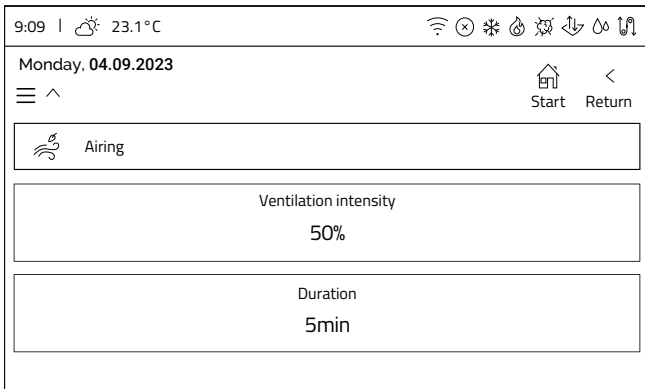

### Edit parameters

Parameter is edited by performing the following steps:

- 1 **Click** the parameter tile.
- 2 Change the value of the parameter using the **+** and **-** buttons or by **clicking** the value axis.
- 3 **Confirm** the new value with the **Confirm** button.

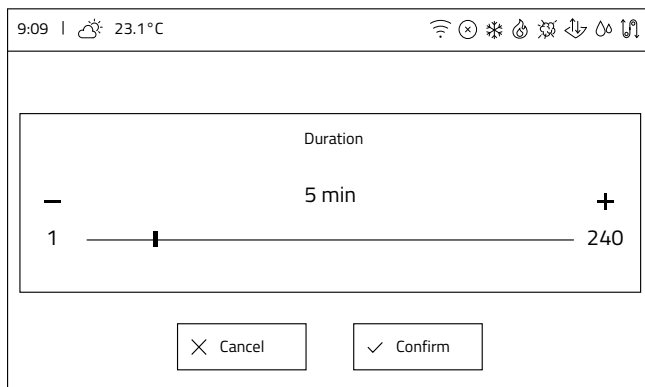

## Empty house

### Empty house screen

**Empty house** momentary operation modes can be activated manually from the home screen or its activation can be scheduled using the **Time mode** tile.

By entering **Airing**, you can enable an additional function performed during the **Empty house** momentary operation mode.

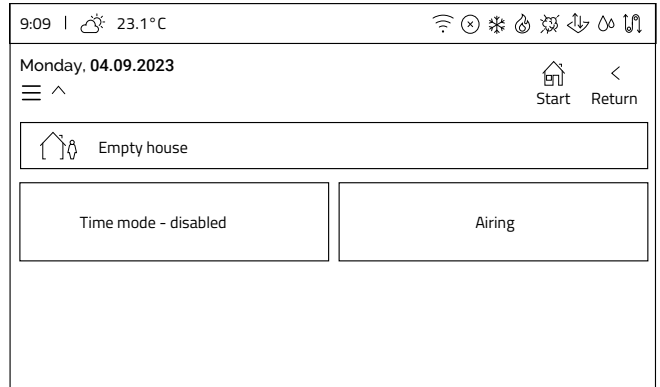

### Empty house mode activation planning

► **Clicking** the **Time mode** tile turns the **Empty house** activation planning on or off. When this option is activated, additional tiles will appear in the window:

- **Start setting**, by **clicking** the tile you can set the day of activation of the momentary mode
- **Setting the end**, by **clicking** the tile you can set the day on which the momentary operation mode is deactivated and the heat recovery unit returns to normal operation

The setting is automatically saved on exit from the option.

**Caution: the device does not check if the entered range is correct**

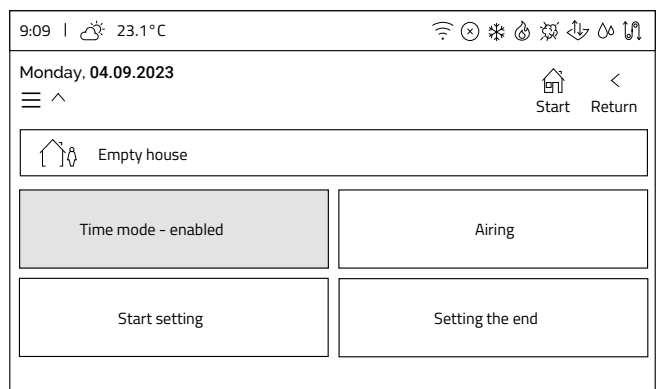



Airing activation

- ▶ When you **click** the **Airing** tile in the main window of momentary mode, the **Airing** window opens.

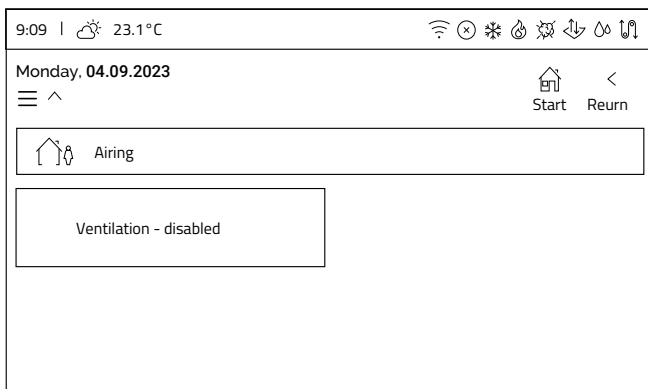

- ▶ **Clicking** the **Airing** tile turns the function on or off. When the function is activated, additional options will be displayed.

Airing settings

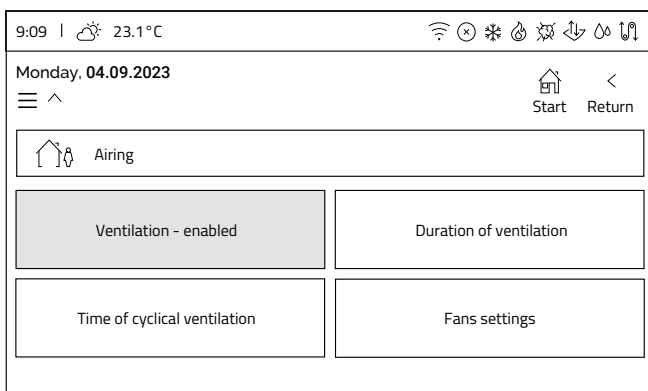

- **Duration of ventilation** - the time during which the fans are operating when Empty house mode is active.
- **Time of cyclical ventilation** - the time during which the fans are not operating when Empty house mode is active.
- **Fans settings** - fans control as a percentage during the airing time countdown, when Empty house mode is active.
- ▶ Settings are changed by **clicking** the relevant tile and then using the **+** and **-** buttons or by **clicking** the value axis to set the desired value. The change is confirmed with the **Confirm** button.

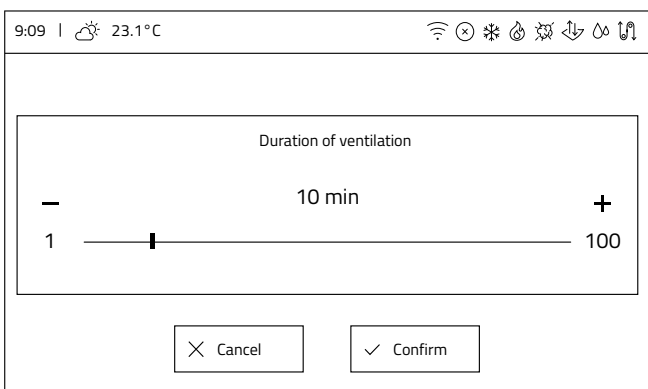

Open window

Open window screen

The **Open window** screen allows two parameters to be edited:

- **Intensity of inlet ventilation**, which determines the percentage of control at which the supply fan will operate during Open window mode
- **Duration** of Open window mode

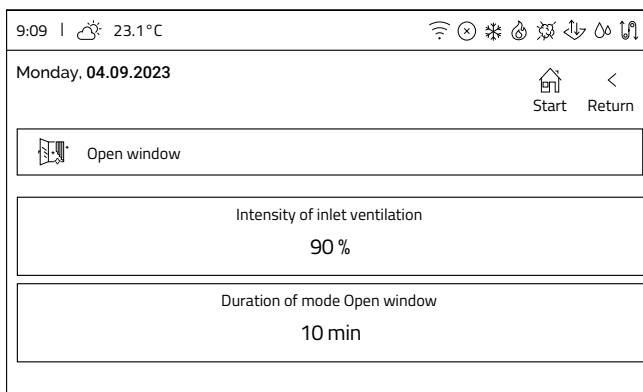

Edit parameters

- ▶ Settings are changed by **clicking** the relevant tile and then using the **+** and **-** buttons or by **clicking** the value axis to set the desired value. The change is confirmed with the **Confirm** button.

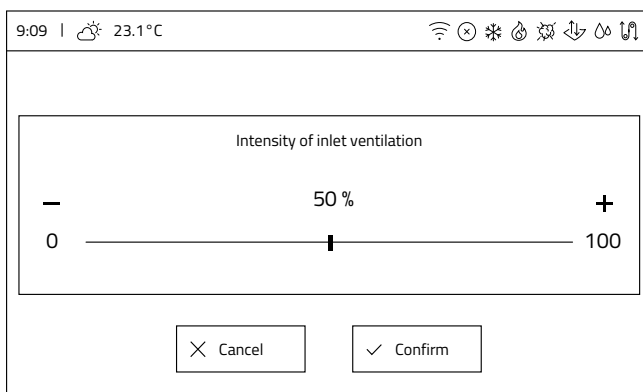

## Fireplace

### Fireplace screen

The **Fireplace** screen allows two parameters to be edited:

- **Increasing the intensity of the inlet air relative to extract air**, which determines the percentage of fan control that will be added to the current supply fan control during Fireplace mode
- **Duration of Fireplace mode**

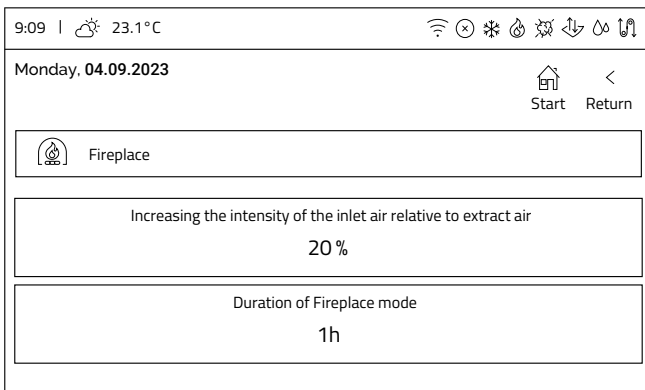

### Edit parameters

- ▶ Settings are changed by **clicking** the relevant tile and then using the **+** and **-** buttons or by **clicking** the value axis to set the desired value. The change is confirmed with the **Confirm** button.

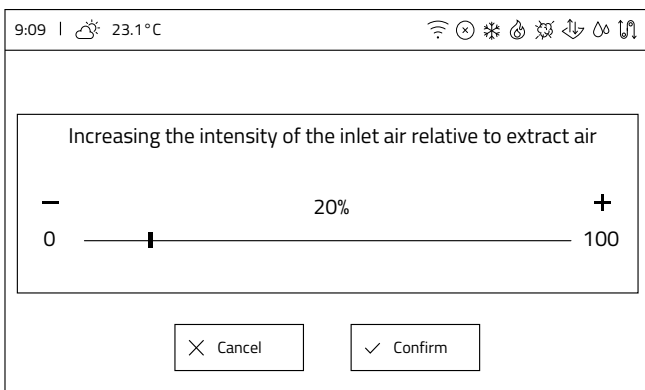

## Kitchen hood

### Kitchen hood screen

The **Kitchen hood** screen allows three parameters to be edited:

- **Increasing the intensity of the inlet air**, which determines the percentage of control that will be added to the current supply fan control during Kitchen hood mode operation
- **Reducing the intensity of the extract air**, which determines the percentage of control that will be subtracted from the current extract fan control during the operation of the Hood mode
- **Duration of the Kitchen hood mode**

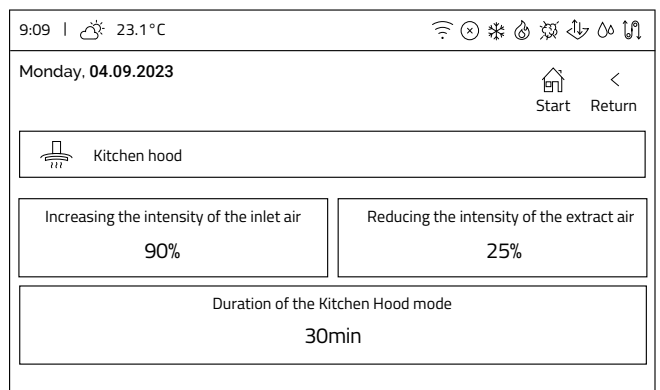

### Edit parameters

- ▶ Settings are changed by **clicking** the relevant tile and then using the **+** and **-** buttons or by **clicking** the value axis to set the desired value. The change is confirmed with the **Confirm** button.

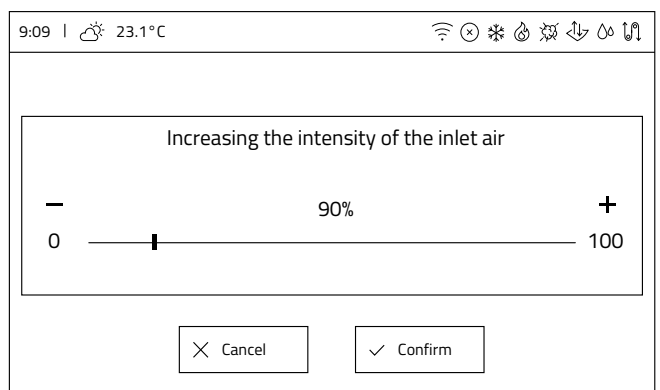

### 3.4.9 Complementary devices

The **Complementary devices** screen, which is opened from the User menu, presents all available devices that support the maintenance of the comfort temperature but are not an integral part of the heat recovery unit, including:

- ground heat exchanger (GHE),
- secondary heater,
- cooler,
- condensing unit (interchangeably as an integration of secondary heater and cooler).

The menu allows the user to quickly enable/disable these devices. The display of available devices must be preceded by their initial configuration by the manufacturer/installer.

If there are no devices configured on the system, a screen will be displayed:

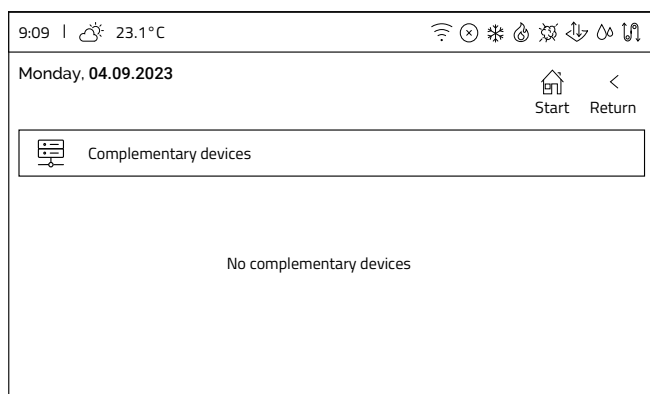

Any item correctly configured will be displayed in this menu. Devices are controlled by pressing the appropriate tile to turn the item on/off, which is indicated by renaming the current state and highlighting the key in green (device ON).

#### Below are sample screens:

- Configuration with the condensing unit OFF and the ground heat exchanger OFF.

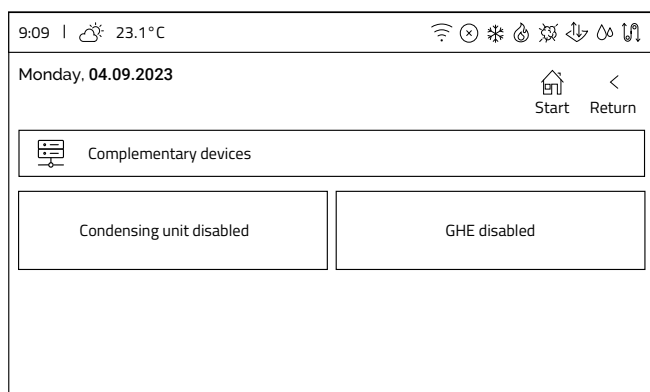

- Configuration with secondary heater ON, cooler ON and ground heat exchanger OFF.

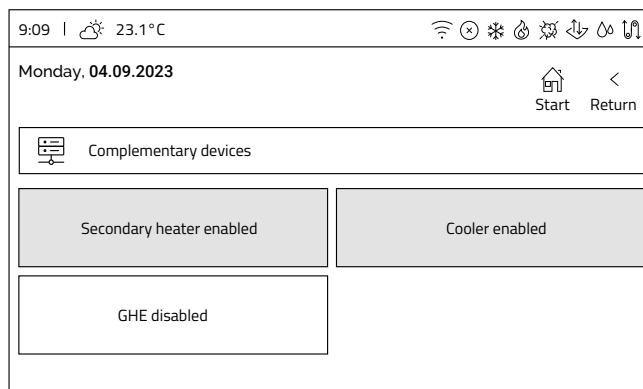

### 3.4.10 Alarms

When there are one or more alarms in the heat recovery unit, the icon on the information bar becomes red (active). The panel also has an audible signal in the form of an intermittent high-pitched sound. When you enter **Alarms** from the **User menu** screen, a window will be displayed in list form to inform you of the current alarms occurring in the heat recovery unit. Each alarm has an associated description to help diagnose the fault.

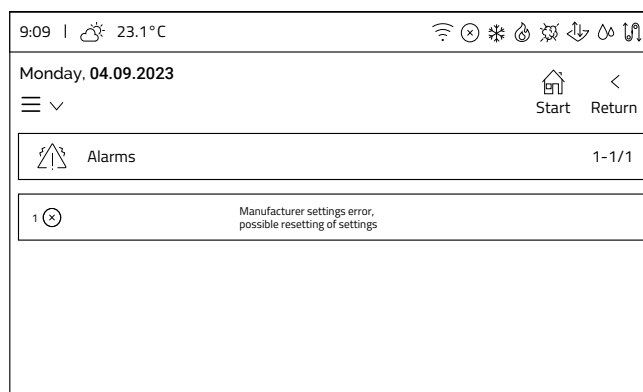

No alarms in the heat recovery unit, the icon on the information bar is greyed out (inactive) and the **Alarms** screen informs us with a message:

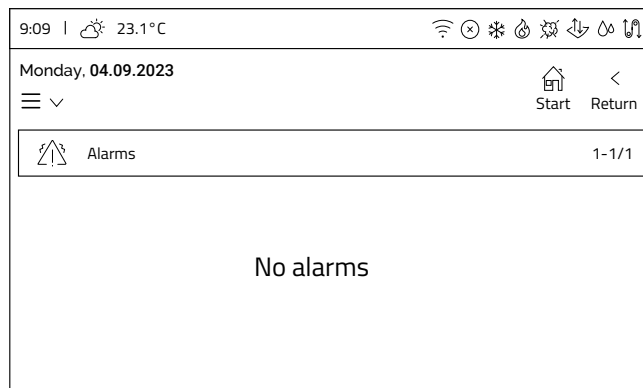

### 3.4.11 Advanced

**Advanced settings** can be changed by entering the following options: **User menu -> Settings -> Advanced settings**. When entering the **Advanced** option, a warning screen will be displayed:

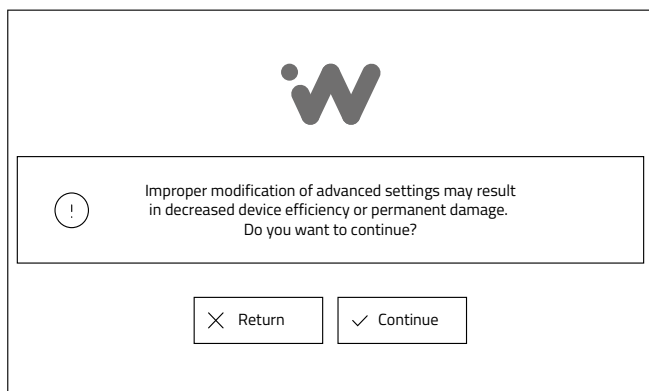

- ▶ It is possible to exit the settings by **clicking** the **Return** button or continue to the **Advanced** settings menu by **selecting** the **Continue** button.
- ▶ Once **accepted**, the **Advanced settings** menu screen will be displayed.

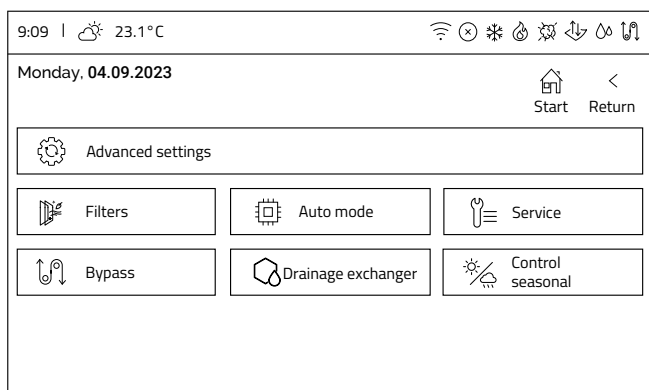

Menu allows changes to be made by the user in heat recovery units, provided that these modules have been made available by the installer.

Window is interactive. Items are displayed depending on on activated equipment options.

#### The screen displays all available options:

- Filters
- Auto mode
- Service\*
- Bypass
- Exchanger drainage
- Seasonal control

*\*Service settings are password-protected, access to this module is held by the installer or service technician.*

### Filter replacement

#### Filters screen

- ▶ The **Filters** screen opens by **clicking** the **Filters** tile on the Advanced settings screen. Depending on your hardware configuration and the filter detection mechanism appropriate for the version of heat recovery unit equipment you have purchased or the settings made by your installer, the appropriate tiles will be displayed.

**Hint:** The **Filters** screen presents information which filters to use in your heat recovery unit.

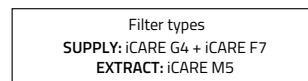

**Hint:** When you **click** the **Order filters** tile, you will see information on your device model and a link to the filter shop.

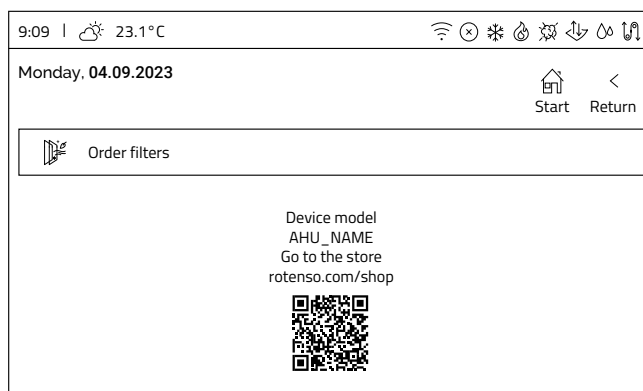

### Filter replacement procedure

#### The iEDGE control system:

#### Timing mechanism for detection of dirty filters

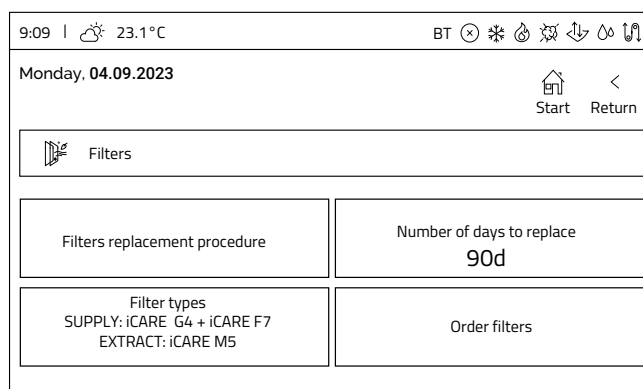

- 1 On the **Filters** screen, **click** the **Filters replacement procedure** tile, which activates the filter replacement process. Follow the instructions displayed on the screen.
- 2 When the **Turn off the the device with the power button located on the ventilation unit...** message occurs go to section **4.1 Air filter replacement** and

follow the steps in that manual, and then return to the control panel.

- 3** When the filter replacement is complete, the **Days left to replace filters** tile will be displayed. After **clicking** it you can set the time after which the heat recovery unit will signal the need to replace the filters. The setting is changed by **clicking** the appropriate tile, then using the **+** and **-** buttons or by **clicking** the value axis to set the desired value. The change is confirmed with the **Confirm** button.
- 4** In the next step, the operation hours counter of the filters is reset. **Click** the **Resetting filter runtime - Start** button. During the procedure, the message **Restarting ...** will be displayed on the button.
- 5** **Start** will be once again displayed on the button when the reset procedure is complete. **Clicking** the **Next** button completes the filter replacement procedure.
- 6** After displaying the screen and confirming with the button **Replacement is successful**, the **filter replacement and calibration procedure** will be completed. After confirmation, the heat recovery unit will automatically return to normal operation.

**The iEDGE SMART control system:**

Detection of dirty filters with a differential pressure transducer

Where the heat recovery unit allows the degree of filter contamination to be checked using differential pressure sensors (separately for supply and extract air filters), the **Filters** screen shows the value of the current degree of filter contamination.

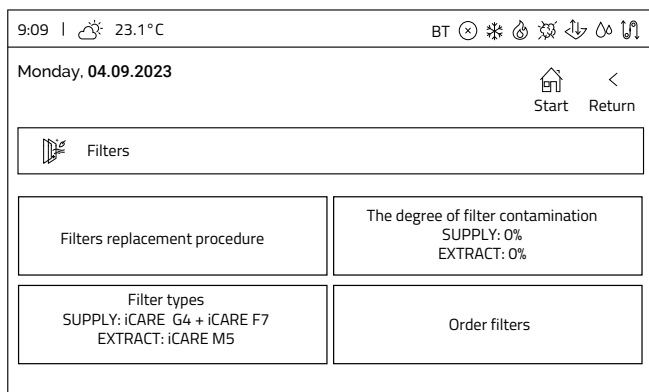

- 1** On the **Filters** screen, **click** the **Filter replacement procedure** tile, which activates the filter replacement process. Follow the instructions displayed on the screen.
- 2** When the **Turn off the the device with the power button located on the ventilation unit...** message occurs go to section **4.1 Air filter replacement** and follow the steps in that manual, and then return to the control panel.
- 3** Once the filter replacement is complete, a calibration procedure will be carried out for the filter contamination measurement system.
- 4** After displaying the screen and confirming with the **Calibration is successful** button, the **filter replacement and calibration procedure** will be

completed. After confirmation the heat recovery unit will automatically return to normal operation.

**Auto mode**

Auto mode screen

- ▶ The **Auto mode** screen opens by **clicking** the **Auto mode** tile on the **Advanced settings** screen. Allows settings for air quality sensor parameters. The priority sensor in this mode is the CO<sub>2</sub> sensor.

**Available sensors are:**

- CO<sub>2</sub>
- RH (humidity)

The top tiles are responsible for the **CO<sub>2</sub> sensor** settings, and the bottom tiles for the **Humidity sensor** settings.

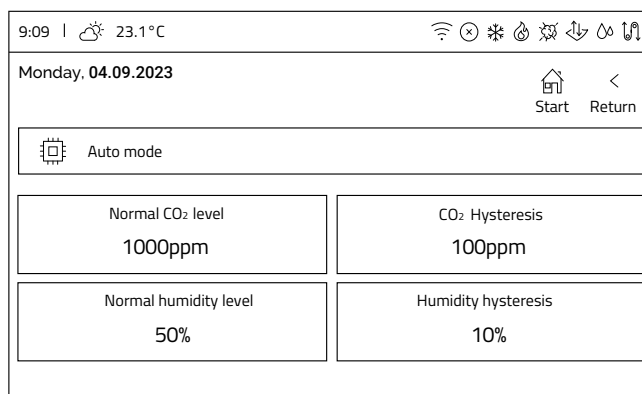

**The available parameters are:**

- **Normal CO<sub>2</sub> level** - defines at what CO<sub>2</sub> level in the extract air from the rooms the heat recovery unit will start to gradually increase the fan control to refresh the air
- **CO<sub>2</sub> hysteresis** - defines at what level of CO<sub>2</sub> concentration below **Normal CO<sub>2</sub> level** the algorithm will stop taking into account the concentration of CO<sub>2</sub>
- **Normal humidity level** - defines at what humidity level in the air extracted from the rooms the heat recovery unit will start to gradually increase the fans control in order to refresh the air
- **Humidity hysteresis** - defines at what humidity level below **Normal humidity level** the algorithm will stop taking humidity into account

Edit parameters

- ▶ Settings are changed by **clicking** the relevant tile and then using the **+** and **-** buttons or by **clicking** the value axis to set the desired value. The change is confirmed with the **Confirm** button.

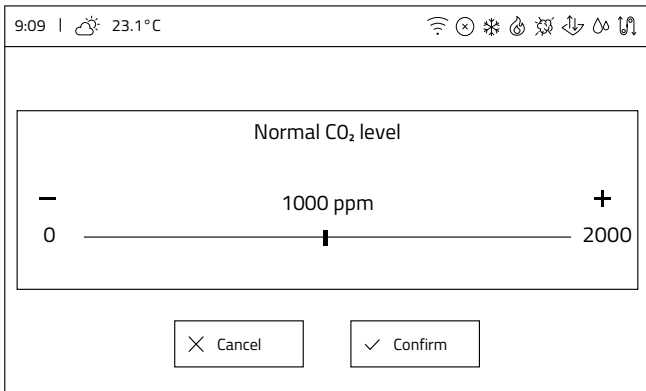

**Bypass**

Bypass screen

- ▶ The **Bypass** screen opens by **clicking** the **Bypass** tile on the **Advanced settings** screen. It allows you to select the operation mode of the bypass. The **Bypass** tile displays the current operation mode.
- ▶ **Clicking** the tile changes the operation mode.

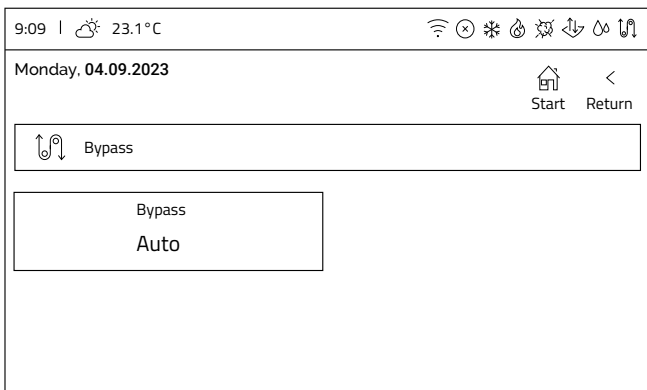

**Operation modes available are:**

- **Auto** - bypass is controlled according to the temperature at the intake and supply air temperatures using the leading temperature and seasonal control
- **Open** - bypass is permanently open
- **Closed** - bypass is permanently closed

**Exchanger drainage**

Exchanger drainage screen

- ▶ The **Exchanger drainage** screen opens by **clicking** the **Exchanger drainage** tile on the **Advanced settings** screen.

Exchanger drainage is an operation mode in which the supply fan and then the extract fan are controlled for a specific period of time. The exchanger is cleaned of accumulated condensed water vapour coming from the air flowing through it. The algorithm is set from the installer menu. User can set the time at which the drainage procedure will start.

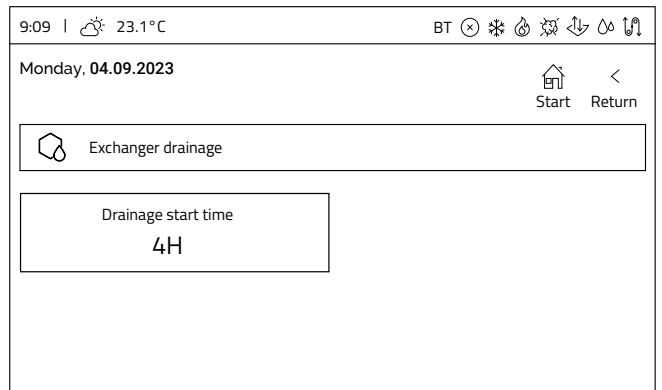

Edit parameters

- ▶ Settings are changed by **clicking** the relevant tile and then using the **+** and **-** buttons or by **clicking** the value axis to set the desired value. The change is confirmed with the **Confirm** button.

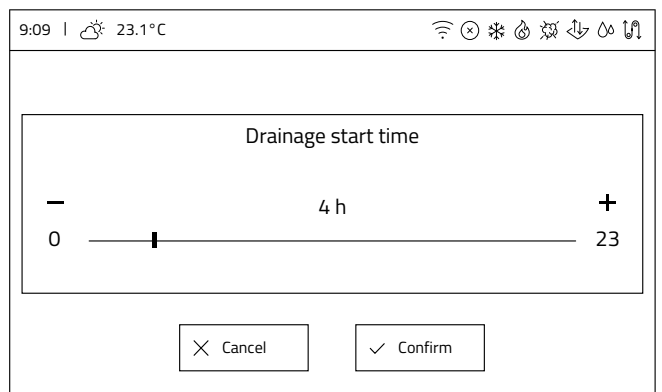

## 4. Maintenance

### 4.1 Air filters replacement

#### NOTE

Regardless of the version of the heat recovery unit assembly, filter replacement operations are carried out in the same way as described below.

#### NOTE

Always use original filters. The use of substitutes may adversely affect the quality of air filtration and the electric consumption of the appliance.

The unit indicates each time the filters need to be replaced by illuminating the filter replacement light on the control panel. Environmental conditions, i.e. the degree of air pollution, the presence of dust or smog in the environment where the ventilation system is located, can have a significant impact on the frequency of filter replacement.

#### Get started with the filter replacement procedure

Before starting to replace the filters, the **Filter replacement** procedure must be activated on the **iSENSE 5i** panel (described in **section 3.4.11 Advanced**), on the iCONNECT mobile app or on the iCONNECT WEB service.

#### 1 Removing the decorative cover

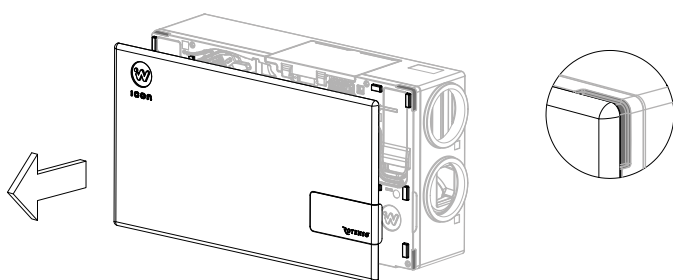

- ▶ **Remove** the decorative cover using the recesses marked in the drawing.

#### 2 Turn off the device

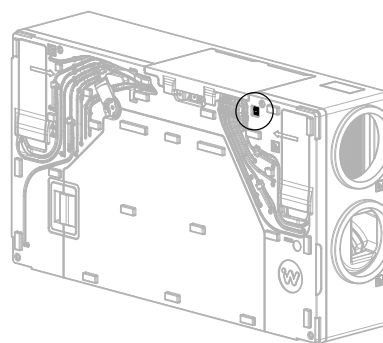

- ▶ **Switch** the power button to the position **O**.

#### 3 Removing the air filter covers

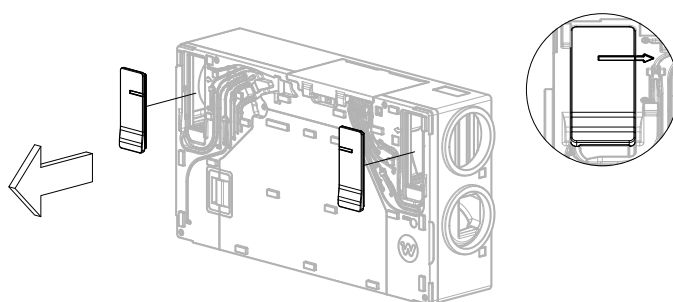

- ▶ **Remove** the air filter covers by **pulling** on the finger recesses while **holding** the heat recovery unit with the other hand.

#### 4 Removing the air filters out of the heat recovery unit housing

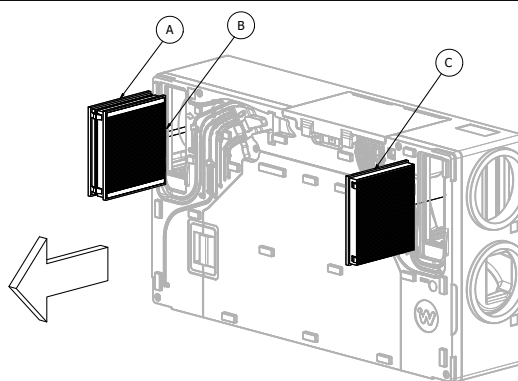

- ▶ **Slide** the air filters out of the housing by **pulling** on the built-in handles.

- (A) Worn iCARE G4 Coarse 75% anti-pollen filter  
- **grab** the ribbons and **pull** them towards you.
- (B) Worn iCARE F7 ePM1 70% anti-smog filter  
- **grab** the ribbons and **pull** them towards you.
- (C) Worn iCARE M5 ePM10 55% anti-pollen filter  
- **grab** the ribbons and **pull** them towards you.

- ▶ **Dispose** used filters.

**5** Inserting new filters into heat recovery unit housing

for the Standard (A) version

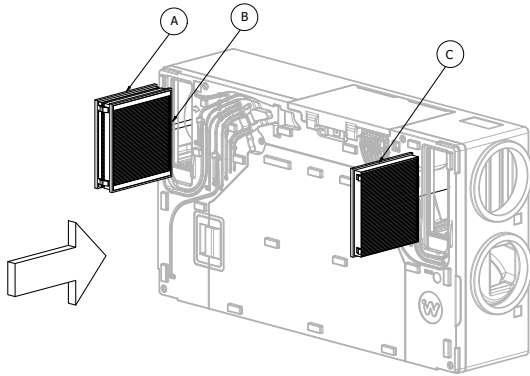

for the Alternative (B) version

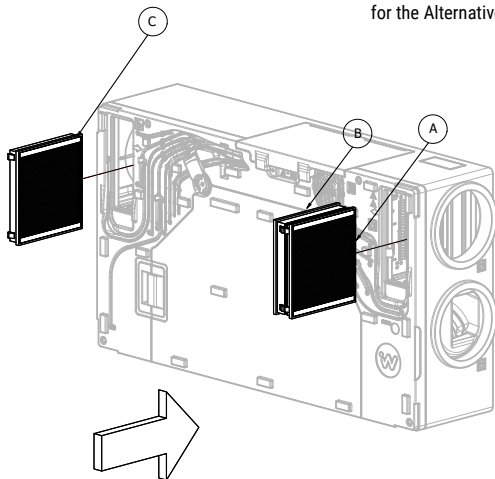

**6** Correct installation of air filters

for the Standard (A) version

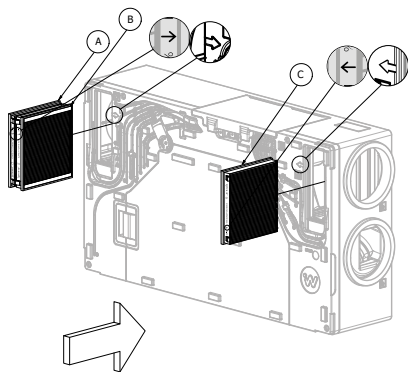

for the Alternative (B) version

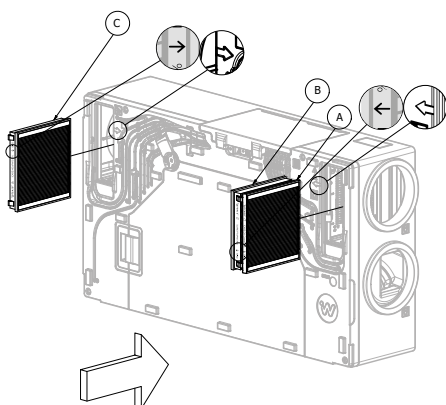

► The arrows printed on the filters must point in line with the arrows on the heat recovery unit housing.

MARK	FILTER NAME
(A)	iCARE G4 COARSE 75%
(B)	iCARE F7 ePM1 70%
(C)	iCARE M5 ePM10 55%

- **Insert** new anti-pollen filter **iCARE G4 COARSE 75%**.
- **Insert** new anti-smog filter **iCARE F7 ePM1 70%**.
- **Insert** new anti-pollen filter **iCARE M5 ePM10 55%**.

**7** Installing the air filter covers

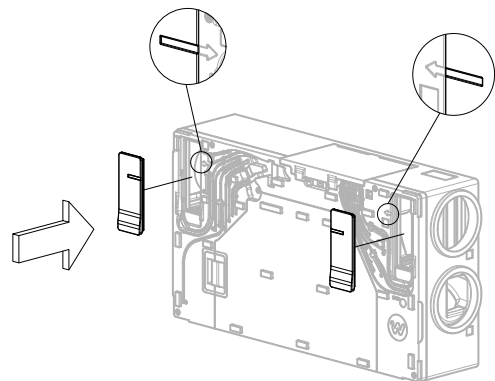

► **Insert** the air filter covers making sure that the arrow on the housing and the recess on the covers align with each other. **Press** down flush with the housing.

**Caution:** If significant resistance is encountered, verify that the cover has been placed correctly in the hole.

**8** Turn on the device

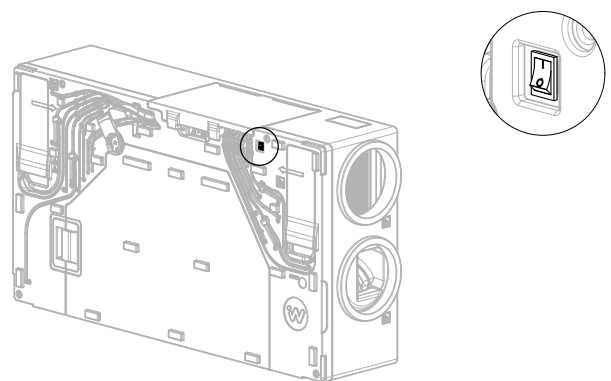

► **Switch** the power button to the position **I**.



**9** Installing the decorative cover

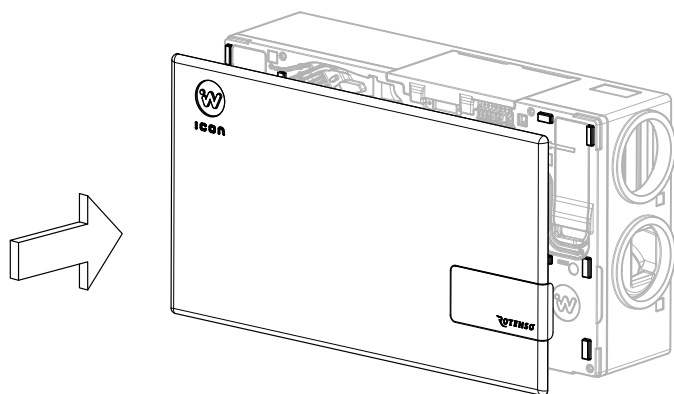

- ▶ **Fit** the decorative cover to the mounting pins.

## 4.2 Heat exchanger cleaning

Check the cleanliness of the heat exchanger once a year. If the heat exchanger is found to be dirty, clean it according to the instructions below.

Each time the heat exchanger cover is removed, check the continuity of the gaskets on the cover.

**1** Removing the decorative cover

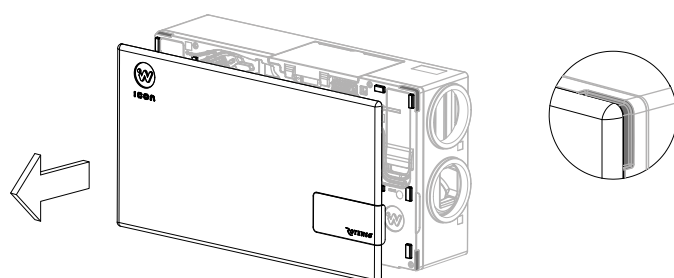

- ▶ **Remove** the decorative cover using the recesses marked in the drawing.

**2** Turn off the device

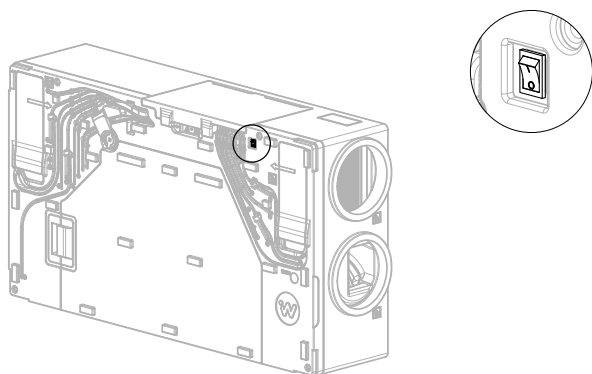

- ▶ **Switch** the power button to the position .

**3** Removing the heat exchanger cover

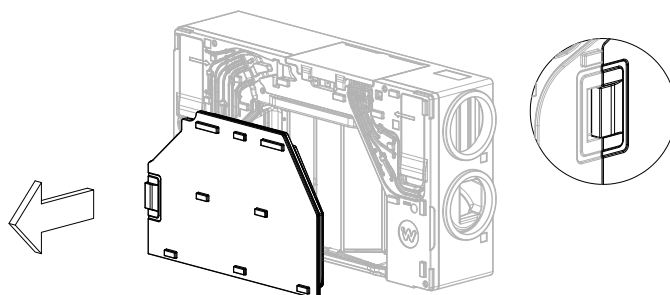

- ▶ **Remove** the cover by **grabbing** the profiled handle, **holding** the heat recovery unit with the other hand. **Pull** the cover towards you taking care not to damage the gaskets.

**4** Removing heat exchanger mounting strips

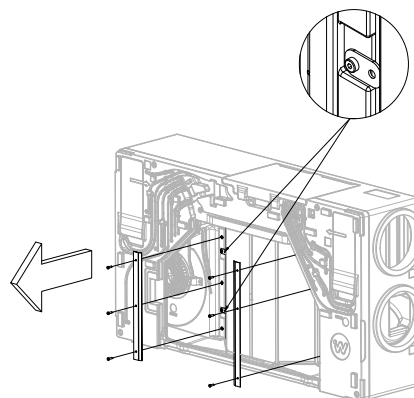

- ▶ Using a **3 mm** allen key, **unscrew** 6 bolts securing heat exchanger mounting strips one by one. **Secure** all bolts for reassembly.
- ▶ **Remove** the mounting strips from the unit.
- ▶ **Rotate** the 4 mounting plates to allow the exchanger to slide out.

**5** Removing the heat exchanger from the housing

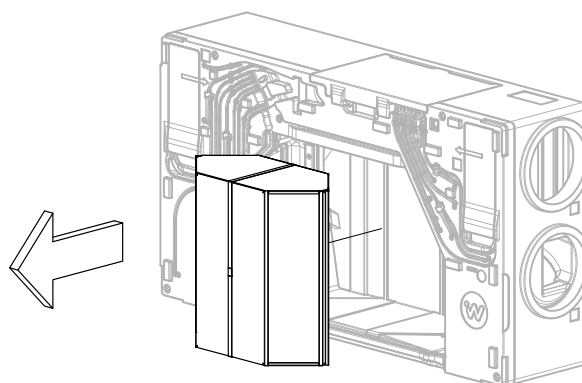

- ▶ **Grab** the strap on the heat exchanger and slowly **pull it out** from the heat recovery unit, **holding** the unit with the other hand while being careful of the side gaskets in the housing.
- ▶ **Check** and, if necessary, **correct** the position of the bottom gasket in the housing.

**Wash the exchanger according to the following steps:**

- 1** **Insert** the exchanger into the tank (i.e. bathtub).
- 2** **Rinse** the exchanger with clean water.
- 3** **Pour** the soap solution into the bottom of the container. Using a small container, **pour** the solution into all the channels of the heat exchanger.
- 4** **Clean** the outer walls of the exchanger with a soft brush.
- 5** Fine **rinse** the soap solution from the exchanger.
- 6** **Remove** standing water from the heat exchanger by rotating the heat exchanger several times.
- 7** **Dry** the exchanger with a dry cloth.
- 8** **Leave** the exchanger to dry one day in a well-ventilated, dry room.

**6** Inserting the heat exchanger into the housing

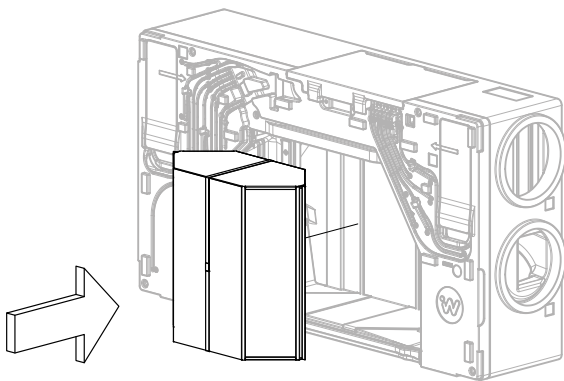

- ▶ **Insert** the washed heat exchanger in the appropriate place, **taking care of** the side gaskets in the housing.
- ▶ **Secure** the heat exchanger against sliding out by turning 4 mounting plates.

**7** Installing heat exchanger mounting strips

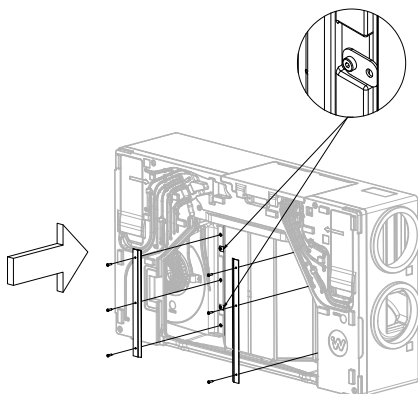

- ▶ **Secure** the heat exchanger with the mounting strips. Using a **3 mm** allen key, **tighten** 6 bolts fixing heat exchanger mounting strips.

**8** Installing the heat exchanger cover

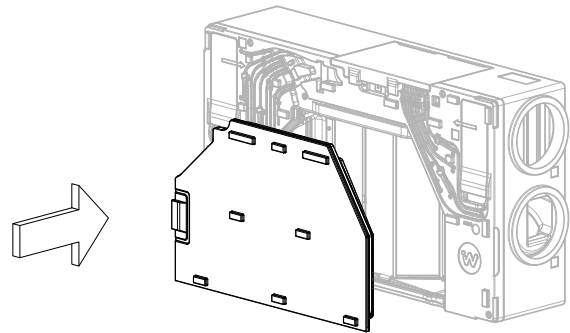

- ▶ **Fit** the heat exchanger cover flush with the housing **taking care** not to damage the gaskets.

**Caution:** If significant resistance is encountered, verify that the cover has been placed correctly in the hole.

**9** Turn on the device

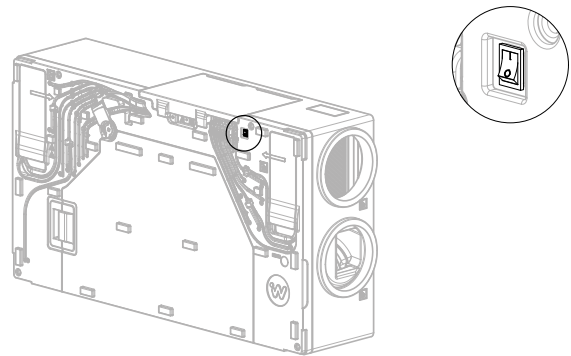

- ▶ **Switch** the power button to position **I**.

**10** Installing the decorative cover

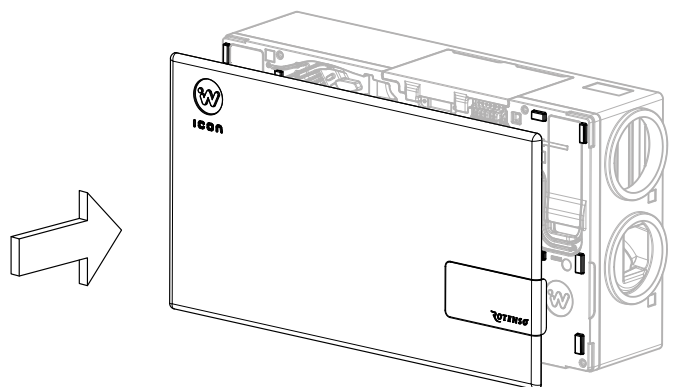

- ▶ **Fit** the decorative cover to the mounting pins.

**4.3 Cleaning the heat recovery unit housing**

When the exterior of the heat recovery unit is dirty, clean the surface with compressed air or a Hoover with a soft tip.

## 5. Faults and operating indications

### 5.1 Faults without indication

The table shows possibly occurring faults without indication on the display and their description and solution.

FAULT	CAUSE	SOLUTION
Device does not switch on	Heat recovery unit is not plugged in	Insert the power cord plug of the appliance into the socket
	The power button under the decorative cover is in the "0" position.	Switch the power button to the "I" position
Noisy work	Dirty air filters	Change the air filters
	Contaminated or damaged fan	Contact the service
	Defective bypass system	Contact the service
Heat recovery unit does not reach the desired flow rate	Dirty air filters	Change the air filters
	Contaminated or damaged fan	Contact the service
	Dirty heat exchanger	Clean the heat exchanger
	Leaks in the system	Contact the Installer
Water leaks from the unit	Leaky drain connection	Correct the seating of the water trap in the heat recovery unit outlet
	Clogged trap	Clear the trap
	Defective siphon	Replace the water trap
Mainboard not connected to control panel	Heat recovery unit communication cable discontinuity between mainboard and control panel	Contact the service
Heat recovery unit has no air supply to the heat recovery unit	Dirty intake	Clean the intake
	Dirty exhaust	Clean the exhaust

### 5.2 Faults with indication

ALARMS	POSSIBLE CAUSE	ALARM SIGNAL	DISPLAY
Damaged supply temperature sensor.	The sensor has been damaged, incorrectly connected or unconfigured.	Alarm signalling, ALARM output active, Heat recovery unit stopped.	Continuously since the cause was noted.
Damaged additional temperature sensor.			
Damaged exhaust temperature sensor.			
Intake temperature sensor damaged.			
Extract temperature sensor damaged.			
Sensor ground heat exchanger temperature defective.			
Temperature sensor damaged.	Regulation lead sensor has been damaged, incorrectly connected or unconfigured.	Alarm signalling, ALARM output active, Heat recovery unit stopped.	Continuously since the cause was noted.
FAS alarm - Heat recovery unit stopped due to external signal.	Active signal from fire alarm system.	Alarm signalling, ALARM output active, FAS operating procedure.	Continuously after the cause has been noted.
Periodic inspection is coming up.	Periodic inspection is coming up - contact service.	Alarm signalling.	Less than 3 days to periodic inspection deadline.
General inspection by the manufacture's service is required	General inspection required - contact the service centre.	Alarm signalling, ALARM output active.	Until a new inspection is entered by the service.
Too high supply air temperature.	Room supply air temperature noted to be too high.	Alarm signalling, ALARM output active, Over-temperature protection procedure.	Continuously since the cause was noted.
Too low supply air temperature	Room supply air temperature noted to be too low.	Alarm signalling, ALARM output active, protection procedure against Under-temperature protection.	Continuously since the cause was noted.

**cont. 5.2 Faults with indication**

ALARMS	POSSIBLE CAUSE	ALARM SIGNAL	DISPLAY
Active Secondary heater thermostat. Warm-up procedure.	A low temperature or signal from the secondary heater thermostat of the water heater was noted - the warm-up procedure was initiated.	Alarm signalling, ALARM output active, warm-up procedure.	Continuously since the cause was noted.
Possible overheating of the pre-heater.	Primary heater thermostat activation has been noted. It may require resetting.	Alarm signalling, ALARM output active, Electric heater alarm procedure.	Continuously since the cause was noted.
Electric preheater overheating - 3x thermostat tripping	High temperature of the electric preheater - triple trigger of the thermostat. Airflow too low, heater thermostat may require Alarms confirmation.	Alarm signalling, ALARM output active, Electric heater cyclic alarm procedure.	Continuously since the cause was noted.
Possible overheating of the secondary heater	Secondary heater thermostat activation was noted. It may require resetting.	Alarm signalling, ALARM output active, Electric heater alarm procedure.	Continuously since the cause was noted.
Secondary heater overheating - 3x thermostat tripping	Secondary heater high temperature - triple trigger of the heater thermostat. Airflow too low, heater thermostat may require Alarms confirmation.	Alarm signalling, ALARM output active, Electric heater alarm procedure.	Continuously since the cause was noted.
Heater thermostat activation	The thermostat of one of the electric heaters was activated. It may need to be reset.	Alarm signalling, ALARM output active, Electric heater cyclic alarm procedure	Continuously since the cause was noted.
Triple activation of the heaters thermostat - confirmation required	High temperature of one of the electric heaters - triple trigger of the thermostat. Airflow too low, heater thermostat may alarm acknowledgement.	Alarm signalling, electric heater cyclic alarm procedure.	Continuously since the cause was noted.
Error in heat recovery unit manufacturer's settings. Possible resetting of settings	Confirmation of Producer's configuration in the Producer's menu deleted or missing.	Alarm signalling, ALARM output active, heat recovery unit stopped.	Continuously since the cause was noted.
Unauthorized start - device locked	Unauthorized attempt to start the device. Contact service to remove the lock.	Alarm signalling, heat recovery unit is stopped and locked	Continuously since. noting of the cause.
No communication with control panel	Possible damage to the transmission cable connecting the panel's mounting frame to the control panel itself.	Alarms signalling, further heat recovery unit operation.	Continuously since the cause was noted.
Communication error from supply air pressure sensor/flow sensor for supply air	Error in communication between control panel and supply air pressure sensor Possible damage to or incorrect connection of sensor.	Alarm signalling, ALARM output active, further heat recovery unit operation.	Continuously since the cause was noted.
Communication error from extract air pressure sensor/flow sensor for extract air	Error in communication between control panel and extract air pressure sensor. Possible damage or incorrect connection of the sensor.	Alarm signalling, ALARM output active, urther heat recovery unit operation.	Continuously since the cause was noted.
No communication with control panel	Possible damage to the transmission cable connecting the panel's mounting frame to the control panel itself.	Alarms signalling, further heat recovery unit operation.	Continuously since the cause was noted.

ALARMS	POSSIBLE CAUSE	ALARM SIGNAL	DISPLAY
Communication error from supply air pressure sensor/flow sensor for supply air	Error in communication between control panel and supply air pressure sensor Possible damage to or incorrect connection of sensor.	Alarm signalling, ALARM output active, further heat recovery unit operation.	Continuously since the cause was noted.
Communication error from extract air pressure sensor/flow sensor for extract air	Error in communication between control panel and extract air pressure sensor. Possible damage or incorrect connection of the sensor.	Alarm signalling, ALARM output active, further heat recovery unit operation.	Continuously since the cause was noted.
The deadline for replacing extract air filter is coming	The deadline for replacing the filter is approaching - depending on your heat recovery unit settings, purchase the filters or contact the service department.	Alarms signalling.	Continuously after the cause is noted, ceasing when the Alarm is accepted.
The deadline for replacing the extract air filter is coming	The deadline for replacing the filter is approaching - depending on your heat recovery unit settings, purchase the filters or contact the service department.	Alarms signalling.	Continuously after the cause is noted, ceasing when the Alarm is accepted.
Dirty supply air filter. Turn off the unit and replace the filter	Dirty filter on the supply duct. Disable the heat recovery unit and replace the corresponding filter.	Alarm signalling, ALARM output active	Continuously after the cause is noted. Once the Alarm is accepted, the Filter replacement procedure proceeds.
Dirty extract air filter. Disable the heat recovery unit and replace the filter	Dirty filter on the extract duct. Disable the heat recovery unit and replace the corresponding filter.	Alarm signalling, ALARM output active	Continuously after the cause is noted. Once the Alarm is accepted, the Filter replacement procedure proceeds
Dirty supply air filter. Call service	Dirty filter on the supply air duct. Call for service to replace air filters.	Alarm signalling, ALARM output active	Continuously after the cause has been noted.
Dirty extract air filter. Call service	Dirty filter on the extract air duct. Call for service to replace air filters.	Alarm signalling, ALARM output active	Continuously after the cause has been noted.
Filter replacement procedure	Filter replacement procedure is active which has stopped the heat recovery unit.	Alarm signalling, Heat recovery unit stopped.	Continuously after the cause has been noted.
Emergency mode - worn filters	The contamination of one of the filters has exceeded the alarm condition. It should be replaced immediately.	Alarm signalling, ALARM output active; alarm procedure for dirty filters	Continuously after the cause has been noted.

## 6. Disposal and recycling

Do not dispose this product as unsorted municipal waste. Collection of such waste separately for special treatment is necessary. Do not dispose of electrical appliances as municipal waste, use separate collection facilities. Contact your local government for information regarding the collection systems available.

If electrical appliances are disposed of in landfills or dumps, hazardous substance can leak into the groundwater and get into the food chain, damaging your health and well-being.

Proper disposal recovers raw materials from used equipment and promotes a circular economy.

## 7. Technical specification

### Rotenso Wentilo ICON IS250 | IS330

Parameter	Unit	IS250 E1 AA IS250 E1 AB	IS250 E4 AA IS250 E4 AB	IS250 S1 AA IS250 S1 AB
Specific energy consumption (cold zone)	kWh/(m <sup>2</sup> x a)	-72.6	-79.6	-77.7
Specific energy consumption class (average zone)	-	A	A	A
Specific energy consumption (average zone)	kWh/(m <sup>2</sup> x a)	-36.2	-41.6	-38.7
Specific energy consumption (warm zone)	kWh/(m <sup>2</sup> x a)	-12.8	-17.2	-13.7
Typology	-	Bidirectional Ventilation Unit (BVU)	Bidirectional Ventilation Unit (BVU)	Bidirectional Ventilation Unit (BVU)
Type of drive	-	Variable speed drive	Variable speed drive	Variable speed drive
Type of heat recovery system	-	Recuperative	Recuperative	Recuperative
Thermal efficiency of heat recovery	%	82.3	82.3	91.5
Maximum flow rate	m <sup>3</sup> /h	250	250	250
Electric power input of the fan drive	W	87.8	87.8	91.3
Sound power level	dB	51	51	51
Reference flow rate	m <sup>3</sup> /s	0.049	0.049	0.049
Reference pressure difference	Pa	50	50	50
Specific Power Input	W/(m <sup>3</sup> /h)	0.25	0.25	0.26
Control factor	-	0.95	0.65	0.95
Control typology	-	Clock control (no DCV) - 0.95	Local demand control - 0.65	Clock control (no DCV) - 0.95
Maximum internal leakage rates	%	2.6	2.6	2.6
Maximum external leakage rates	%	2.2	2.2	2.2
Position of visual filter warning		Control panel and/or mobile application and/or web application	Control panel and/or mobile application and/or web application	Control panel and/or mobile application and/or web application
Description of visual filter warning		Control panel: highlighted notification icon. Control panel with screen: highlighted notification icon and text information. Mobile application: text notification. Web application: text notification. Regular filter changes guarantee correct operation of the unit. Extensive clogging of filters decreases energy efficiency of the unit and increases noise level.		
Pre-/dis-assembly instructions URL		rotenso.com	rotenso.com	rotenso.com
Annual Electricity Consumption	kWh/a	324.3	175.7	335.9
Annual Heating Saved at cold climate	kWh/a	8 538.8	8869.6	9083.4
Annual Heating Saved at average climate	kWh/a	4 364.8	4534.0	4643.2
Annual Heating Saved at warm climate	kWh/a	1 973.7	2050.2	2099.6

IS250 S4 AA IS250 S4 AB	IS330 E1 AA IS330 E1 AB	IS330 E4 AA IS330 E4 AB	IS330 S1 AA IS330 S1 AB	IS330 S4 AA IS330 S4 AB
-83.2	-70.5	-78.3	-75.5	-81.9
A+	A	A	A	A+
-43.4	-34.8	-40.8	-37.2	-42.5
-18.0	-11.7	-16.7	-12.6	-17.4
Bidirectional Ventilation Unit (BVU)	Bidirectional Ventilation Unit (BVU)	Bidirectional Ventilation Unit (BVU)	Bidirectional Ventilation Unit (BVU)	Bidirectional Ventilation Unit (BVU)
Variable speed drive	Variable speed drive	Variable speed drive	Variable speed drive	Variable speed drive
Recuperative	Recuperative	Recuperative	Recuperative	Recuperative
91.5	80.0	80.0	89.2	89.2
250	330	330	330	330
91.3	135.7	135.7	140.3	140.3
51	57	57	57	57
0.049	0.064	0.064	0.064	0.064
50	50	50	50	50
0.26	0.27	0.27	0.29	0.29
0.65	0.95	0.65	0.95	0.65
Local demand control - 0.65	Clock control (no DCV) - 0.95	Local demand control - 0.65	Clock control (no DCV) - 0.95	Local demand control - 0.65
2.6	1.9	1.9	1.9	1.9
2.2	1.7	1.7	1.7	1.7
Control panel and/or mobile application and/or web application	Control panel and/or mobile application and/or web application	Control panel and/or mobile application and/or web application	Control panel and/or mobile application and/or web application	Control panel and/or mobile application and/or web application
<p>Control panel: highlighted notification icon.                      Control panel with screen: highlighted notification icon and text information.                      Mobile application: text notification.                      Web application: text notification.                      Regular filter changes guarantee correct operation of the unit.                      Extensive clogging of filters decreases energy efficiency of the unit and increases noise level.</p>				
rotenso.com	rotenso.com	rotenso.com	rotenso.com	rotenso.com
181.2	354.7	190.0	369.4	196.9
9242.3	8402.6	8776.5	8947.2	9149.1
4724.4	4295.2	4486.3	4573.6	4676.8
2136.3	1942.2	2028.7	2068.1	2114.8

## NOTEBOOK

A series of horizontal dotted lines for writing, spanning the width of the page.







[rotenso.com](https://rotenso.com)

Thermosilesia Sp. z o.o. Sp.k  
ul. Szyb Walenty 16  
41-700 Ruda Śląska